

5/2-way valve

manually operated

PLUS

Art. No. 106464

Type No. 514.111

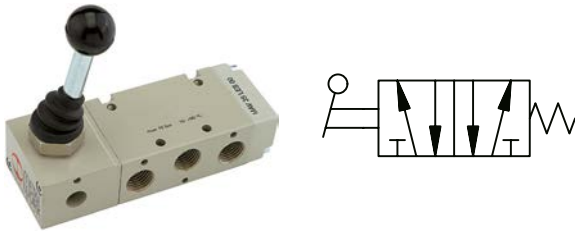

Exemplary illustration

Traditional way valves of series 70 in manually operated version with hand lever. These valves are also suitable for use with vacuum.

Technical data

Operating pressure	Max. vacuum 10 bar
Temperature range	-10 to 60 °C
Valve body	Aluminium
Piston	Nickel-plated aluminium
Medium	Filtered compressed air with or without lubrication. If lubricated, then continuous.
Sealant	NBR
Spring	Special steel
Flow rate measurement 1	Flow rate at 6 bar and Δp 0.5 bar
Flow rate 1	400 NI/min
Flow rate measurement 2	Flow rate at 6 bar and Δp 1.0 bar
Flow rate 2	550 NI/min
Connection	G 1/8
Function	5/2
Operation	Monostable
Symbol	12
Series	Valves series 70

Commercial data

Customs tariff number	84818079
Country of origin	IT
eCl@ss 5.1.4	27291801
eCl@ss 9.0	27291390
UNSPSC_Code_v190501	40141603
UNSPSC_CodeDesc_v190501	Pneumatic valves

VALVES SERIES 70

The Series 70 forms part of Metal Work's full range of traditional valves.

They are available in sizes 1/8", 1/4", 3/8" and 1/2", versions 3/2, 5/2, 5/3 and double 3/2, with mechanical, manual, pneumatic and electric drives.

They can be installed in line, onto a wall, on the cylinder (using a special bracket) or in series (on a multiple or modular base) to suit all possible applications.

A range of valves (Series 70 LT) designed using components for specific low-temperature applications is now available for the most commonly used types and sizes.

These highly reliable valves comply with the main applicable standards, including Atex, ISO 13489 and SIL, as stated in the documents and certificates available online.



TECHNICAL DATA		1/8"	1/4"	3/8"	1/2"
Thread on the valve ports		1/8"	1/4"	3/8"	1/2"
Operating pressure series 70 versions	bar	2.5 to 10			
monostable and bistable differential		1 to 10			
bistable		vacuum to 10			
asserved					
Operating pressure series 70 LT (low temperature) versions	bar	vacuum to 10			
hand operated		vacuum to 10			-
pneumatic and solenoid/pneumatic		5 to 10			-
	t = -40°C to -10°C	3 to 10			-
	t = -10°C to +60°C				-
Minimum pilot pressure	bar	2.5			
Operating temperature range	°C	-10 to +60			
series 70 versions		-40 to +60			
series 70 LT (low temperature) versions					
Nominal diameter	mm	5	7.5	13.3	15
Conductance C	Nl/min · bar	121.43	264.26	505.52	971.43
Critical ratio b	bar/bar	0.32	0.27	0.32	0.43
Flow rate at 6 bar ΔP 0.5 bar	Nl/min	400	750	1560	3200
Flow rate at 6 bar ΔP 1 bar	Nl/min	550	1100	2150	4600
Installation		In any position (vertical assembly is not recommended for bistable valves subjected to vibration)			
Fluid		Filtered air without lubrication; lubrication, if used, must be continuous.			
Recommended lubricant		For series 70 LT (low-temperature) versions, it is recommended to use of perferamente dried air. ISO and UNI FD 22			
Maximum coil nut torque	Nm	For series 70 LT (low-temperature) it is not expected to be used with lubricated air. 1			
Compatibility with oils		See chapter Z1			

COMPONENTS SERIES 70

- ① VALVE BODY: Aluminium
- ② CONTROL/END CAP: plastic
- ③ SPOOL: chemically nickel-plated aluminium
- ④ DISTANCE PLATES: plastic
- ⑤ GASKETS: NBR
- ⑥ PISTONS: Hostaform®
- ⑦ PISTON GASKET: NBR
- ⑧ FILTER: plastic
- ⑨ SPRINGS: special steel
- ⑩ OPERATOR: Brass pipe - Stainless steel core

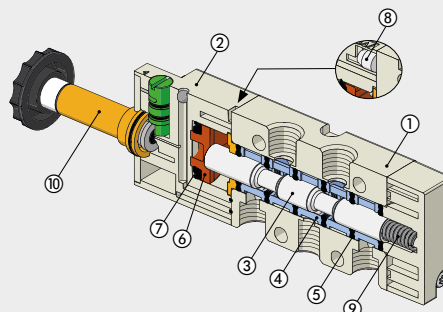

COMPONENTS SERIES 70 LT (LOW TEMPERATURE)

- ① ALVE BODY: aluminium
- ② CONTROL/END CAP: aluminium
- ③ SPOOL: chemically nickel-plated aluminium
- ④ DISTANCE PLATES: plastic
- ⑤ GASKETS: HNBR
- ⑥ PISTONS: aluminium
- ⑦ PISTON GASKET: HNBR
- ⑧ FILTER: plastic
- ⑨ SPRINGS: special steel
- ⑩ OPERATOR: brass pipe - Stainless steel core
(version specific for low-temperature applications)

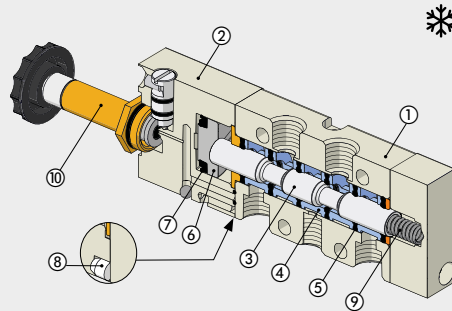

VALVES

VALVES SERIES 70

FLOW CHARTS

VALVES SERIES 70 1/8"

Flow rates

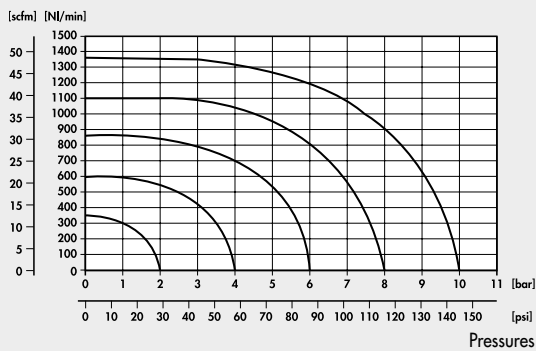

VALVES SERIES 70 1/4"

Flow rates



VALVES SERIES 70 3/8"

Flow rates

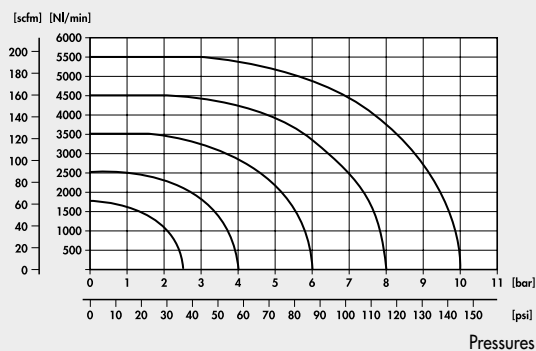

VALVES SERIES 70 1/2"

Flow rates



VALVES SERIES 70, HAND OPERATED

VALVES

VALVES SERIES 70, HAND OPERATED

TECHNICAL DATA		1/8"	1/4"	1/2"
Operating pressure range:				
• version with direct control	bar	Vacuum to 10		
• pilot-assisted version	bar	2.5 to 10		
Operating temperature range				
	°C	-10 to +60		
Nominal diameter				
	mm	5	7.5	15
Conductance C	Nl/min · bar	121.43	264.26	971.43
Critical ratio b	bar/bar	0.32	0.27	0.43
Flow rate at 6 bar ΔP 0.5 bar	Nl/min	400	750	3200
Flow rate at 6 bar ΔP 1 bar	Nl/min	550	1100	4600



SYNOPTIC, SIZES AND VERSIONS					
M A V FAMILY	2 DIMENSIONS	3 FUNCTION	P P OPERATORS 14	S RESETTING (12)	N C FURTHER DETAILS
MAV manual valves	2 1/8" 3 1/4" 4 1/2"	3 3/2 5 5/2 6 5/3 8 2 x 3/2	PP drawer VL axial lever LE 90° lever BRE arranged for manual panel actuators	A pneumatic/mechanical springs* S mechanical springs B bistable D differential O stable for 5/3	NC normally closed NO normally open OO no indication CC closed centres OC open centres PC pressure centres

*on demand

VALVES SERIES 70, HAND OPERATED, 1/8"

90° LEVER 3/2 1/8"

Symbol	Code	Abbrev.	Weight [g]
	7010000100	MAV 23 LES NC	168
	7010000200	MAV 23 LEB OO	171

90° LEVER 5/2 1/8"

Symbol	Code	Abbrev.	Weight [g]
	7010000300	MAV 25 LES OO	194
	7010000400	MAV 25 LEB OO	197

FRONT LEVER 3/2, 1/8"

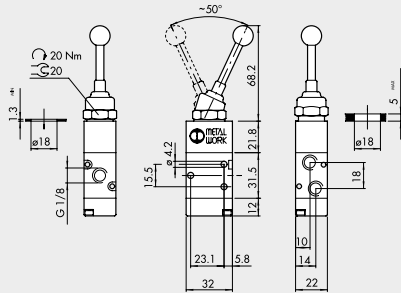

Symbol	Code	Abbrev.	Weight [g]
	7010001400	MAV 23 VLB OO	130

FRONT LEVER 5/2, 1/8"

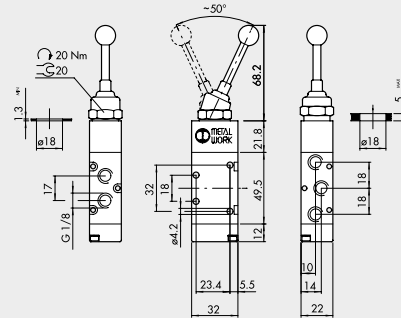

Symbol	Code	Abbrev.	Weight [g]
	7010001700	MAV 25 VLB OO	156

VALVES

VALVES SERIES 70, HAND OPERATED

FRONT LEVER 5/3, 1/8"

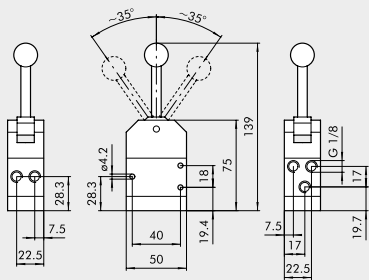

Symbol	Code	Abbrev.	Weight [g]
	7010001150	MAV 28 VLO OC	316
	7010001160	MAV 28 VLS OC	325

90° LEVER 5/3, 1/8"

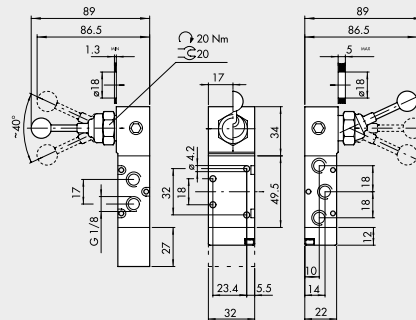

Symbol	Code	Abbrev.	Weight [g]
	7010001000	MAV 26 LES CC	242
	7010000900	MAV 26 LES OC	242
	7010001100	MAV 26 LES PC	242
	7010000500	MAV 26 LEO CC	194
	7010000600	MAV 26 LEO OC	194
	7010000700	MAV 26 LEO PC	194

DRAWER 3/2, 1/8"

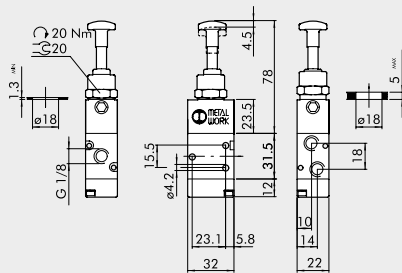

Symbol	Code	Abbrev.	Weight [g]
	7010001300	MAV 23 PPB OO	134
	7010001200	MAV 23 PPS NC	134

DRAWER 5/2, 1/8"

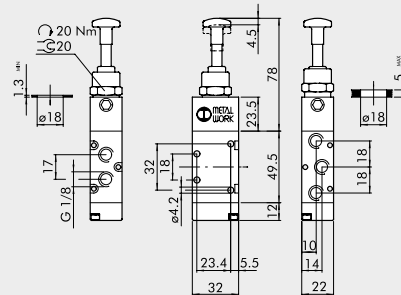

Symbol	Code	Abbrev.	Weight [g]
	7010001600	MAV 25 PPB OO	160
	7010001500	MAV 25 PPS OO	160

PILOT-ASSISTED PLUNGER 3/2 1/8" FOR PANEL ACTUATORS

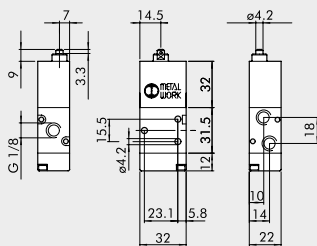

Symbol	Code	Abbrev.	Weight [g]
	7010001800	MAV 23 BRE NC	124

PILOT-ASSISTED PLUNGER 5/2 1/8" FOR PANEL ACTUATORS

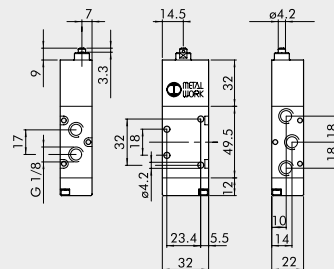

Symbol	Code	Abbrev.	Weight [g]
	7010001900	MAV 25 BRE OO	150

ASSEMBLY DIAGRAM FOR PILOT-ASSISTED HAND-OPERATED VALVES SERIES 70 WITH PANEL ACTUATORS

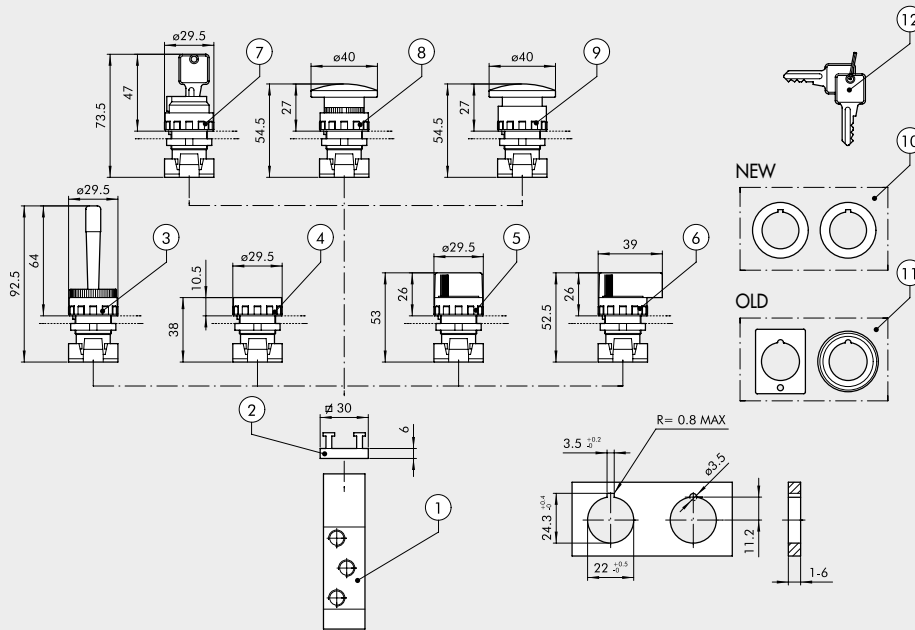

VALVES

VALVES SERIES 70, HAND OPERATED

ORDERING CODES

Symbol	Reference	Code	Description	Weight [g]
	①	7010001800	Pilot-assisted plunger 3/2, 1/8"	124
	①	7010001900	Pilot-assisted plunger 5/2, 1/8"	150
	②	0351000050	2 places adaptor thickness 6.8 mm	5
	③	W0351000015	Red handler with horizontally pivoted lever	25
	④	W0351000011	Fat push button + 2 red/black coloured disks ◆ Bistable fat push button without disk	15
	⑤	W0351000030	Black selector short lever at 2 positions with return	20
	⑤	W0351000031	Black selector short lever at 2 positions	20
	⑤	W0351000032	Black selector short lever at 3 positions with return	20
	⑤	W0351000033	Black selector short lever at 3 positions	20
	⑥	W0351000034	Black selector long lever at 2 positions with return	26
	⑥	W0351000035	Black selector long lever at 2 positions	26
	⑥	W0351000036	Black selector long lever at 3 positions with return	26
	⑥	W0351000037	Black selector long lever at 3 positions	26
	⑦	W0351000016	2 positions key selector with extractable key in 2 positions	50
	⑦	W0351000018	2 positions key selector with extractable key in 0	50
	⑧	W0351000013	Red mushroom-head push button Ø 40	27
	⑧	W0351000017	Black mushroom-head push button Ø 40	27
	⑨	W0351000014	Red mushroom-head push button with lock Ø 40	29
	◆	W0351000049	◆ Reducer from 30 to 22.5 mm	
	▲	W0351000050	▲ Adapter for bore Ø 30 G2326	
	♣	W0351000021	♣ Key for ESC selectors	
		W0351000056	Green disk for push button ④	

◆ It can't be supplied. As working replaced by selector with bistable short lever at 2 positions (⑤).
 ♣ Usable only with technopolymer body selectors.
 ▲ Usable only with metal body selectors.

VALVES SERIES 70, HAND-OPERATED, 1/4"

VALVES

VALVES SERIES 70, HAND OPERATED

90° LEVER 3/2, 1/4"

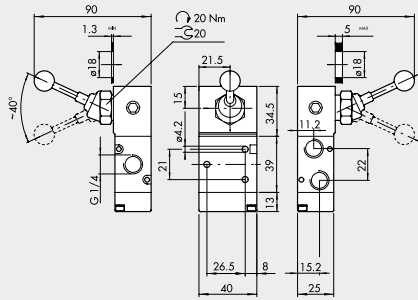

Symbol	Code	Abbrev.	Weight [g]
	7020000100	MAV 33 LES NC	244
	7020000200	MAV 33 LEB OO	244

90° LEVER 5/2, 1/4"

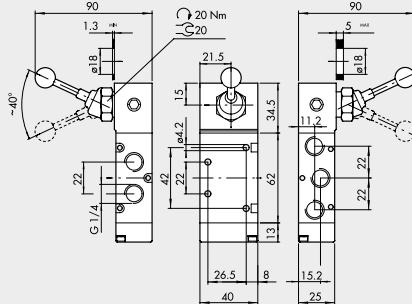

Symbol	Code	Abbrev.	Weight [g]
	7020000300	MAV 35 LES OO	290
	7020000400	MAV 35 LEB OO	290

FRONT LEVER 3/2, 1/4"

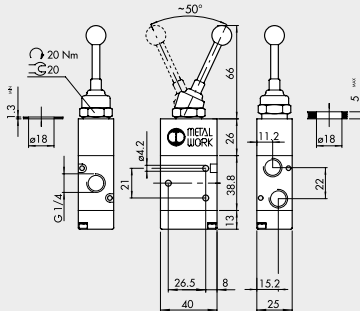

Symbol	Code	Abbrev.	Weight [g]
	7020001400	MAV 33 VLB OO	194

FRONT LEVER 5/2, 1/4"

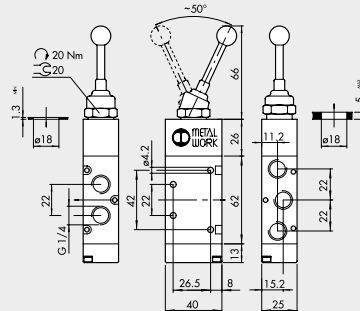

Symbol	Code	Abbrev.	Weight [g]
	7020001700	MAV 35 VLB OO	244

90° LEVER 5/3, 1/4"

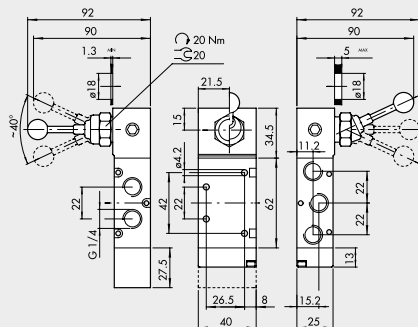



Symbol	Code	Abbrev.	Weight [g]
	7020001000	MAV 36 LES CC	354
	7020000900	MAV 36 LES OC	354
	7020001100	MAV 36 LES PC	354
	7020000500	MAV 36 LEO CC	288
	7020000600	MAV 36 LEO OC	288
	7020000700	MAV 36 LEO PC	288

VALVES SERIES 70, HAND OPERATED, 1/2"

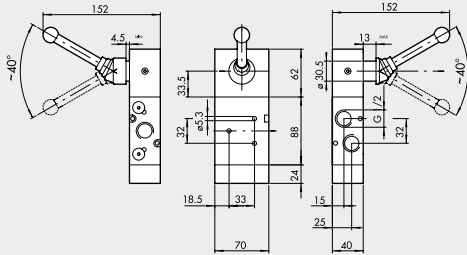

90° LEVER 3/2, 1/2"



Symbol	Code	Abbrev.	Weight [g]
	7030000100	MAV 43 LES NC	1443
	7030000200	MAV 43 LEB OO	1435

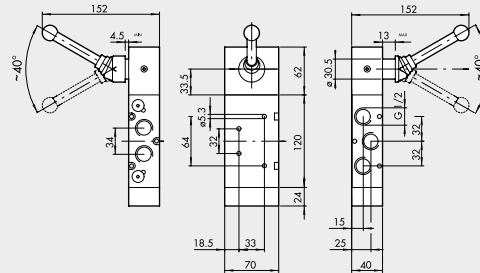



90° LEVER 5/2, 1/2"

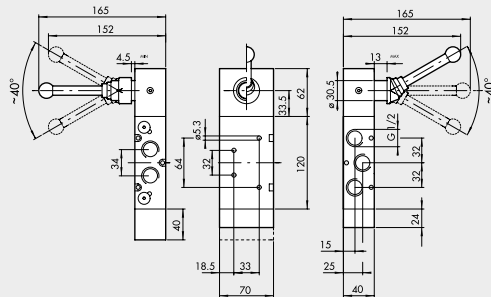

Symbol	Code	Abbrev.	Weight [g]
	7030000300	MAV 45 LES OO	1588
	7030000400	MAV 45 LEB OO	1630

90° LEVER 5/3, 1/2"



Symbol	Code	Abbrev.	Weight [g]
	7030001000	MAV 46 LES CC	1810
	7030000900	MAV 46 LES OC	1800
	7030001100	MAV 46 LES PC	1800
	7030000500	MAV 46 LEO CC	1615
	7030000600	MAV 46 LEO OC	1605
	7030000700	MAV 46 LEO PC	1605

NOTES

VALVES

VALVES SERIES 70, HAND OPERATED

Accessories

	Art. No.	Type No.
Mounting bracket set, height 120.0 mm	106604	518.120-18
Mounting bracket set, height 60.0 mm	106605	518.60-18
Mounting bracket set, height 30.0 mm	106606	518.30-18
Feed block with 2 valve positions	106610	518.02-18
Feed block with 3 valve positions	106611	518.03-18
Feed block with 4 valve positions	106612	518.04-18
Feed block with 5 valve positions	106613	518.05-18
Feed block with 6 valve positions	106614	518.06-18
Feed block with 7 valve positions	106615	518.07-18