

5/3-way valve

electropneumatic

PLUS ||

Art. No. 106584

Type No. 517.321

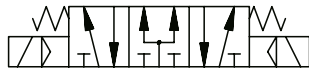

Exemplary illustration

Traditional way valves of series 70 in electropneumatic version. These valves have a wide range of applications as bushing valves, direct mounting on the cylinder with special adapters or as series valves with multi-base plates and individual interlinking plates (supply strips).

Technical data

| | |
|-------------------------|--|
| Operating pressure | 10 bar |
| Medium temperature | -10 to 60 °C |
| Ambient temperature | -10 to 50 °C |
| Medium | Filtered compressed air with or without lubrication. If lubricated, then continuous. |
| Sealant | NBR |
| Flow rate measurement 1 | Flow rate at 6 bar and Δp 0.5 bar |
| Flow rate 1 | 400 NI/min |
| Flow rate measurement 2 | Flow rate at 6 bar and Δp 1.0 bar |
| Flow rate 2 | 550 NI/min |
| Connection | G 1/8 |
| DN | 5 |
| Operation | Mid-position pressurised |
| Function | 5/3 |
| Manual control | latching |
| Series | Valves series 70 |
| Voltage | 24 V DC |
| Scope of delivery | with connector and coil |

Commercial data

| | |
|-------------------------|------------------|
| Customs tariff number | 84818079 |
| Country of origin | IT |
| eCl@ss 5.1.4 | 27291501 |
| eCl@ss 9.0 | 27291390 |
| UNSPSC_Code_v190501 | 40141603 |
| UNSPSC_CodeDesc_v190501 | Pneumatic valves |

Material informations

| | |
|----------------------------|-------------------------|
| REACH SVHC1 substance name | lead |
| CAS no. SVHC 1 | 7439-92-1 |
| REACH Info | contains SVHC substance |

VALVES SERIES 70

The Series 70 forms part of Metal Work's full range of traditional valves.

They are available in sizes 1/8", 1/4", 3/8" and 1/2", versions 3/2, 5/2, 5/3 and double 3/2, with mechanical, manual, pneumatic and electric drives.

They can be installed in line, onto a wall, on the cylinder (using a special bracket) or in series (on a multiple or modular base) to suit all possible applications.

A range of valves (Series 70 LT) designed using components for specific low-temperature applications is now available for the most commonly used types and sizes.

These highly reliable valves comply with the main applicable standards, including Atex, ISO 13489 and SIL, as stated in the documents and certificates available online.



| TECHNICAL DATA | | 1/8" | 1/4" | 3/8" | 1/2" |
|--|--------------------|---|--------|--------|--------|
| Thread on the valve ports | | 1/8" | 1/4" | 3/8" | 1/2" |
| Operating pressure series 70 versions | bar | 2.5 to 10 | | | |
| monostable and bistable differential | | 1 to 10 | | | |
| bistable | | vacuum to 10 | | | |
| asserved | | | | | |
| Operating pressure series 70 LT (low temperature) versions | bar | vacuum to 10 | | | |
| hand operated | | 5 to 10 | | | - |
| pneumatic and solenoid/pneumatic | t = -40°C to -10°C | 3 to 10 | | | - |
| | t = -10°C to +60°C | | | | - |
| Minimum pilot pressure | bar | 2.5 | | | |
| Operating temperature range | °C | -10 to +60 | | | |
| series 70 versions | | -40 to +60 | | | |
| series 70 LT (low temperature) versions | | | | | |
| Nominal diameter | mm | 5 | 7.5 | 13.3 | 15 |
| Conductance C | Nl/min · bar | 121.43 | 264.26 | 505.52 | 971.43 |
| Critical ratio b | bar/bar | 0.32 | 0.27 | 0.32 | 0.43 |
| Flow rate at 6 bar ΔP 0.5 bar | Nl/min | 400 | 750 | 1560 | 3200 |
| Flow rate at 6 bar ΔP 1 bar | Nl/min | 550 | 1100 | 2150 | 4600 |
| Installation | | In any position (vertical assembly is not recommended for bistable valves subjected to vibration) | | | |
| Fluid | | Filtered air without lubrication; lubrication, if used, must be continuous. | | | |
| Recommended lubricant | | For series 70 LT (low-temperature) versions, it is recommended to use of perferamente dried air. ISO and UNI FD 22 | | | |
| Maximum coil nut torque | Nm | For series 70 LT (low-temperature) it is not expected to be used with lubricated air. 1 | | | |
| Compatibility with oils | | See chapter Z1 | | | |

COMPONENTS SERIES 70

- ① VALVE BODY: Aluminium
- ② CONTROL/END CAP: plastic
- ③ SPOOL: chemically nickel-plated aluminium
- ④ DISTANCE PLATES: plastic
- ⑤ GASKETS: NBR
- ⑥ PISTONS: Hostaform®
- ⑦ PISTON GASKET: NBR
- ⑧ FILTER: plastic
- ⑨ SPRINGS: special steel
- ⑩ OPERATOR: Brass pipe - Stainless steel core



COMPONENTS SERIES 70 LT (LOW TEMPERATURE)

- ① ALVE BODY: aluminium
- ② CONTROL/END CAP: aluminium
- ③ SPOOL: chemically nickel-plated aluminium
- ④ DISTANCE PLATES: plastic
- ⑤ GASKETS: HNBR
- ⑥ PISTONS: aluminium
- ⑦ PISTON GASKET: HNBR
- ⑧ FILTER: plastic
- ⑨ SPRINGS: special steel
- ⑩ OPERATOR: brass pipe - Stainless steel core
(version specific for low-temperature applications)



VALVES

VALVES SERIES 70

FLOW CHARTS

VALVES SERIES 70 1/8"

Flow rates



VALVES SERIES 70 1/4"

Flow rates



VALVES SERIES 70 3/8"

Flow rates



VALVES SERIES 70 1/2"

Flow rates





VALVES SERIES 70, SOLENOID/PNEUMATIC

| TECHNICAL DATA | | 1/8" | 1/4" | 3/8" | 1/2" |
|--|--------------|---------------------------------------|--------|--------|--------|
| Operating pressure: | | | | | |
| • monostable and bistable differential | bar | 2.5 to 10 | | | |
| • bistable | bar | 1 to 10 | | | |
| • asserved | bar | Vacuum to 10 | | | |
| Minimum pilot pressure | bar | 2.5 | | | |
| Operating temperature range | °C | -10 to +60 | | | |
| Nominal diameter | mm | 5 | 7.5 | 13.3 | 15 |
| Conductance C | NI/min · bar | 121.43 | 264.26 | 505.52 | 971.43 |
| Critical ratio b | bar/bar | 0.32 | 0.27 | 0.32 | 0.43 |
| Flow rate at 6 bar ΔP 0.5 bar | NI/min | 400 | 750 | 1560 | 3200 |
| Flow rate at 6 bar ΔP 1 bar | NI/min | 550 | 1100 | 2150 | 4600 |
| TRA / TRR monostable at 6 bar | ms | 15/35 | 19/45 | 21/72 | 36/100 |
| TRA / TRR bistable at 6 bar | ms | 20/20 | 21/21 | 18/18 | 25/25 |
| Coil voltage values | | 12; 24 VDC - 24; 110; 220V AC 50/60Hz | | | |
| Power | | 2 W (DC) 3.5VA (AC) | | | |
| Voltage tolerance | % | -10 to +15 | | | |
| Insulation class | | F 155 | | | |
| Maximum coil nut torque | Nm | 1 | | | |
| Hand operator | | Bistable | | | |

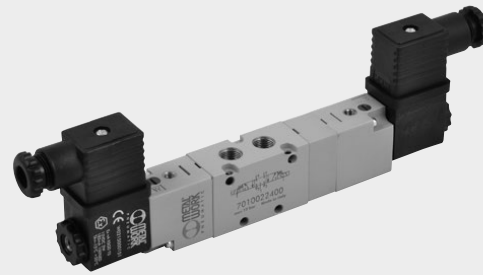

VALVES

SYNOPTIC, SIZES AND VERSIONS

| SO V | 2 | 3 | SO | S | NC |
|-------------------------|------------|-----------|----------------------|---------------------------------|---|
| FAMILY | DIMENSIONS | FUNCTION | OPERATORS 14 | RESETTING (12) | FURTHER DETAILS |
| SOV solenoid/ pneumatic | 2 1/8" | 3 3/2 | SO solenoid | S mechanical springs | OO no indication |
| | 3 1/4" | 5 5/2 | SE solenoid assisted | B bistable | NC normally closed |
| | C 3/8" | 6 5/3 | | D differential | NO normally open |
| | 4 1/2" | ■ 8 2-3/2 | | P pneumatic | CC closed centres |
| | | | | ◆ A pneumatic/mechanical spring | OC open centres |
| | | | | | PC pressure centres |
| | | | | | ▲ NC-NO normally closed - normally open |

- Only available for size 1/8" and 1/4"
- ◆ On demand
- ▲ Only available for function 2-3/2

VALVES SERIES 70, PNEUMATIC

VALVES SERIES 70, SOLENOID/PNEUMATIC, PILOT-ASSISTED SOLENOID/PNEUMATIC, 1/8"

MONOSTABLE 3/2 NO, 1/8"



| Symbol | Code | Abbrev. | Weight [g] |
|--------|------------|---------------|------------|
| | 7010020400 | SOV 23 SOS NO | 100 |

MONOSTABLE 3/2 NC, 1/8"



| Symbol | Code | Abbrev. | Weight [g] |
|--------|------------|---------------|------------|
| | 7010020200 | SOV 23 SOS NC | 100 |
| | 7010020500 | SOV 23 SES NC | 100 |

MONOSTABLE 5/2, 1/8"



| Symbol | Code | Abbrev. | Weight [g] |
|--------|------------|---------------|------------|
| | 7010021100 | SOV 25 SOS OO | 128 |
| | 7010021500 | SOV 25 SES OO | 129 |

BISTABLE 5/2, 1/8"



| Symbol | Code | Abbrev. | Weight [g] |
|--------|------------|---------------|------------|
| | 7010021200 | SOV 25 SOB OO | 160 |
| | 7010021300 | SOV 25 SOD OO | 166 |
| | 7010021600 | SOV 25 SEB OO | 160 |

BISTABLE 3/2, 1/8"



| Symbol | Code | Abbrev. | Weight [g] |
|--------|------------|---------------|------------|
| | 7010020100 | SOV 23 SOB OO | 135 |
| | 7010020300 | SOV 23 SEB OO | 136 |

DOUBLE 3/2, 1/8"



| Symbol | Code | Abbrev. | Weight [g] |
|--------|------------|------------------|------------|
| | 7010023100 | SOV 28 SOS NC | 186 |
| | 7010023200 | SOV 28 SOS NO | 186 |
| | 7010023300 | SOV 28 SOS NC-NO | 186 |
| | 7010023400 | SOV 28 SES NC | 186 |
| | 7010023500 | SOV 28 SES NO | 186 |
| | 7010023600 | SOV 28 SES NC-NO | 186 |

MONOSTABLE 5/3, 1/8"



NOTES

| Symbol | Code | Abbrev. | Weight [g] |
|--------|------------|---------------|------------|
| | 7010022100 | SOV 26 SOS CC | 190 |
| | 7010022200 | SOV 26 SOS OC | 190 |
| | 7010022300 | SOV 26 SOS PC | 190 |
| | 7010022400 | SOV 26 SES CC | 188 |
| | 7010022500 | SOV 26 SES OC | 188 |
| | 7010022600 | SOV 26 SES PC | 188 |

VALVES SERIES 70, SOLENOID/PNEUMATIC, PILOT-ASSISTED SOLENOID/ PNEUMATIC, 1/4"

MONOSTABLE 3/2 NO, 1/4"



| Symbol | Code | Abbrev. | Weight [g] |
|--------|------------|---------------|------------|
| | 7020020400 | SOV 33 SOS NO | 152 |

MONOSTABLE 3/2 NC, 1/4"

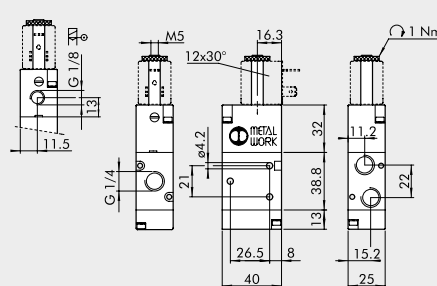

| Symbol | Code | Abbrev. | Weight [g] |
|--------|------------|---------------|------------|
| | 7020020200 | SOV 33 SOS NC | 152 |
| | 7020020500 | SOV 33 SES NC | 152 |

VALVES

VALVES SERIES 70, SOLENOID/PNEUMATIC

MONOSTABLE 5/2, 1/4"

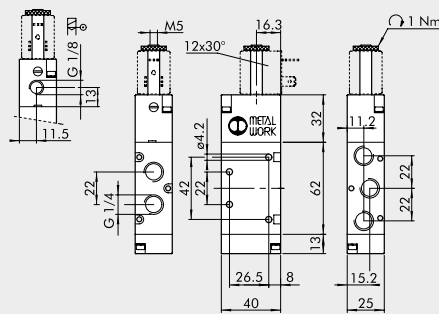

| Symbol | Code | Abbrev. | Weight [g] |
|--------|------------|---------------|------------|
| | 7020021100 | SOV 35 SOS OO | 200 |
| | 7020021500 | SOV 35 SES OO | 200 |

BISTABLE 5/2, 1/4"



| Symbol | Code | Abbrev. | Weight [g] |
|--------|------------|---------------|------------|
| | 7020021200 | SOV 35 SOB OO | 236 |
| | 7020021300 | SOV 35 SOD OO | 252 |
| | 7020021600 | SOV 35 SEB OO | 242 |

BISTABLE 3/2, 1/4"

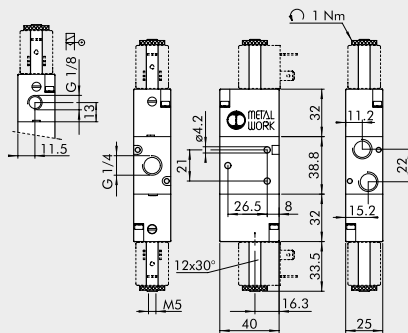

| Symbol | Code | Abbrev. | Weight [g] |
|--------|------------|---------------|------------|
| | 7020020100 | SOV 33 SOB OO | 190 |
| | 7020020300 | SOV 33 SEB OO | 190 |

DOUBLE 3/2, 1/4"



| Symbol | Code | Abbrev. | Weight [g] |
|--------|------------|------------------|------------|
| | 7020023100 | SOV 38 SOS NC | 286 |
| | 7020023200 | SOV 38 SOS NO | 286 |
| | 7020023300 | SOV 38 SOS NC-NO | 286 |
| | 7020023400 | SOV 38 SES NC | 286 |
| | 7020023500 | SOV 38 SES NO | 286 |
| | 7020023600 | SOV 38 SES NC-NO | 286 |

MONOSTABLE 5/2, 3/8"



| Symbol | Code | Abbrev. | Weight [g] |
|--------|------------|---------------|------------|
| | 7040021100 | SOV C5 SOS OO | 361 |
| | 7040021500 | SOV C5 SES OO | 361 |

BISTABLE 5/2, 3/8"



| Symbol | Code | Abbrev. | Weight [g] |
|--------|------------|---------------|------------|
| | 7040021200 | SOV C5 SOB OO | 400 |
| | 7040021300 | SOV C5 SOD OO | 425 |
| | 7040021600 | SOV C5 SEB OO | 400 |

BISTABLE 3/2, 3/8"



| Symbol | Code | Abbrev. | Weight [g] |
|--------|------------|---------------|------------|
| | 7040020100 | SOV C3 SOB OO | 307 |
| | 7040020300 | SOV C3 SEB OO | 307 |

MONOSTABLE 5/3, 3/8"

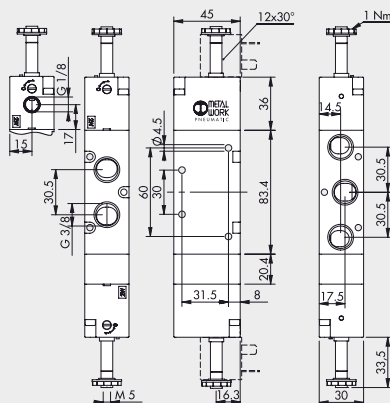

| Symbol | Code | Abbrev. | Weight [g] |
|--------|------------|---------------|------------|
| | 7040022100 | SOV C6 SOS CC | 476 |
| | 7040022200 | SOV C6 SOS OC | 474 |
| | 7040022300 | SOV C6 SOS PC | 474 |
| | 7040022400 | SOV C6 SES CC | 476 |
| | 7040022500 | SOV C6 SES OC | 474 |
| | 7040022600 | SOV C6 SES PC | 474 |

**VALVES SERIES 70, SOLENOID/PNEUMATIC,
PILOT-ASSISTED SOLENOID/PNEUMATIC, 1/2"**

MONOSTABLE 3/2 NO, 1/2"



MONOSTABLE 3/2 NC, 1/2"



| Symbol | Code | Abbrev. | Weight [g] |
|--------|------------|---------------|------------|
| | 7030020400 | SOV 43 SOS NO | 660 |

| Symbol | Code | Abbrev. | Weight [g] |
|--------|------------|---------------|------------|
| | 7030020200 | SOV 43 SOS NC | 660 |
| | 7030020500 | SOV 43 SES NC | 654 |

MONOSTABLE 5/2, 1/2"

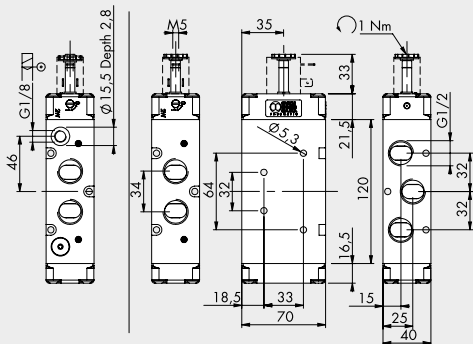

BISTABLE 5/2, 1/2"



| Symbol | Code | Abbrev. | Weight [g] |
|--------|------------|---------------|------------|
| | 7030021100 | SOV 45 SOS OO | 828 |
| | 7030021500 | SOV 45 SES OO | 830 |

| Symbol | Code | Abbrev. | Weight [g] |
|--------|------------|---------------|------------|
| | 7030021200 | SOV 45 SOB OO | 860 |
| | 7030021300 | SOV 45 SOD OO | 868 |
| | 7030021600 | SOV 45 SEB OO | 854 |

VALVES

VALVES SERIES 70, SOLENOID/PNEUMATIC

BISTABLE 3/2, 1/2"



MONOSTABLE 5/3, 1/2"



| Symbol | Code | Abbrev. | Weight [g] |
|--------|------------|---------------|------------|
| | 7030020100 | SOV 43 SOB OO | 686 |
| | 7030020300 | SOV 43 SEB OO | 678 |

| Symbol | Code | Abbrev. | Weight [g] |
|--------|------------|---------------|------------|
| | 7030022100 | SOV 46 SOS CC | 1265 |
| | 7030022200 | SOV 46 SOS OC | 1265 |
| | 7030022300 | SOV 46 SOS PC | 1265 |
| | 7030022400 | SOV 46 SES CC | 1252 |
| | 7030022500 | SOV 46 SES OC | 1252 |
| | 7030022600 | SOV 46 SES PC | 1252 |

ACCESSORIES FOR SERIES 70 SOLENOID/PNEUMATIC VALVES

Refer to page B1.60 for coils and connectors



NOTES

COILS AND CONNECTORS FOR SERIES 70, NAMUR AND SERIES BASIC VALVES

VALVES

COILS AND CONNECTORS FOR SERIES 70, NAMUR AND SERIES BASIC VALVES

COILS SIDE 22 mm

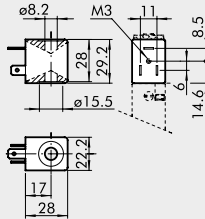

- Voltage tolerance: -10% + 15%
- Insulation class: F155
- Degree of protection: IP65 DIN 40050 with connector
- Avoid prolonged exposure to atmospheric agents
- Coil temperature 100% ED: 55°C at 20°C ambient temperature
- According to Atex 2014/34/EU rule, group 2, category 3 GD
- Electrical connection DIN 43650 B-IND

| Code | Abbrev. | Nominal voltage | Absorption | |
|-------------|-----------------------------|-----------------|------------|---------|
| | | | Inrush | Holding |
| W0215000151 | Coil 22 Ø 8 BA 2W-12VDC | 12Vcc | 2W | 2W |
| W0215000101 | Coil 22 Ø 8 BA 2W-24VDC | 24Vcc | 2W | 2W |
| W0215000111 | Coil 22 Ø 8 BA 3.5VA-24VAC | 24V 50/60Hz | 5.3VA | 3.5VA |
| W0215000121 | Coil 22 Ø 8 BA 3.5VA-110VAC | 110V 50/60Hz | 5.3VA | 3.5VA |
| W0215000131 | Coil 22 Ø 8 BA 3.5VA-220VAC | 220V 50/60Hz | 5.3VA | 3.5VA |

"UL" AND "CSA" COILS 22 mm

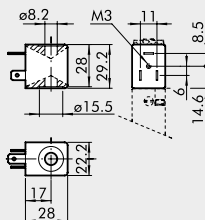

- Voltage tolerance: -10% to + 15%
- Insulation class: F155
- Degree of protection: IP65 EN60529 with connector
- Avoid prolonged exposure to the atmospheric agents
- Coil temperature 100% ED: 55°C at 20°C ambient temperature
- Electrical connection DIN 43650 B-IND

| Code | Abbrev. | Nominal voltage | Absorption | |
|-------------|--------------------------------|-----------------|------------|---------|
| | | | Inrush | Holding |
| W0215000251 | Coil 22 Ø 8 BA 2W-12VDC UR | 12Vcc | 2W | 2W |
| W0215000201 | Coil 22 Ø 8 BA 2W-24VDC UR | 24Vcc | 2W | 2W |
| W0215000211 | Coil 22 Ø 8 BA 3.5VA-24VAC UR | 24V 50/60Hz | 5.3VA | 3.5VA |
| W0215000221 | Coil 22 Ø 8 BA 3.5VA-110VAC UR | 110V 50/60Hz | 5.3VA | 3.5VA |
| W0215000231 | Coil 22 Ø 8 BA 3.5VA-220VAC UR | 220V 50/60Hz | 5.3VA | 3.5VA |

CONNECTOR FOR COILS SIDE 22 mm DIN 43650 B-IND

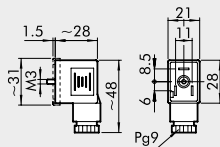

| Code | Tipo | Colour | Ø Cable |
|-------------|----------------|-------------|---------|
| W0970510011 | Standard | Black | PG9 |
| W0970510012 | LED 24V | Transparent | PG9 |
| W0970510013 | LED 110V | Transparent | PG9 |
| W0970510014 | LED 220V | Transparent | PG9 |
| W0970510015 | LED + VDR 24V | Transparent | PG9 |
| W0970510016 | LED + VDR 110V | Transparent | PG9 |
| W0970510017 | LED + VDR 220V | Transparent | PG9 |
| W0970510070 | Atex II 2 GD | Black | PG9 |

KIT COIL EEXM

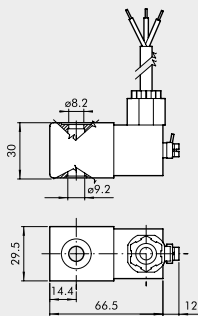

| Code | Description |
|------------|--|
| 0227606913 | Kit for coil .30 24VDC EEXMT5 cable 3 m |
| 0227606915 | Kit for coil .30 24VDC EEXMT5 cable 5 m |
| 0227608013 | Kit for coil .30 24VAC EEXMT5 cable 3 m |
| 0227608015 | Kit for coil .30 24VAC EEXMT5 cable 5 m |
| 0227608023 | Kit for coil .30 110VAC EEXMT5 cable 3 m |
| 0227608025 | Kit for coil .30 110VAC EEXMT5 cable 5 m |
| 0227608033 | Kit for coil .30 230VAC EEXMT5 cable 3 m |
| 0227608035 | Kit for coil .30 230VAC EEXMT5 cable 5 m |

According to Atex 2014/34/EU rule: Ex II 2G Ex mb IIC T4/T5 Gb
 Ex II 2D Ex tb IIIC T130/T95 °C IP66 Db

N.B.: Supplied complete with adapter for Ø8 mm sleeve.
 N.B.: It's not possible to mount valves having these coils on bases or on manifolds, because the width of 29.5 mm is higher than the distance between the valves. Special bases can be manufactured on request.

KIT COILS SIDE 22 IP65



| Code | Description |
|------------|-------------------------|
| 0222100100 | Kit for coils 22 - IP65 |

Improved IP65 protection, even after prolonged exposure to atmospheric agents.
 Applicable to valves with a technopolymer control.

Accessories

| | Art. No. | Type No. |
|--|-----------------|-----------------|
| Mounting bracket set, height 120.0 mm | 106604 | 518.120-18 |
| Mounting bracket set, height 60.0 mm | 106605 | 518.60-18 |
| Mounting bracket set, height 30.0 mm | 106606 | 518.30-18 |
| Feed block with 2 valve positions | 106610 | 518.02-18 |
| Feed block with 3 valve positions | 106611 | 518.03-18 |
| Feed block with 4 valve positions | 106612 | 518.04-18 |
| Feed block with 5 valve positions | 106613 | 518.05-18 |
| Feed block with 6 valve positions | 106614 | 518.06-18 |
| Feed block with 7 valve positions | 106615 | 518.07-18 |
| Manifold base for 2 valve positions | 106622 | 520.02-18 |
| Manifold base for 3 valve positions | 106623 | 520.03-18 |
| Manifold base for 4 valve positions | 106624 | 520.04-18 |
| Manifold base for 5 valve positions | 106625 | 520.05-18 |
| Manifold base for 6 valve positions | 106626 | 520.06-18 |
| Manifold base for 7 valve positions | 106627 | 520.07-18 |
| Manifold base for 8 valve positions | 106628 | 520.08-18 |
| Manifold base for 9 valve positions | 106629 | 520.09-18 |
| Manifold base for 10 valve positions | 106630 | 520.10-18 |
| Modular bases for manifold base system | 146733 | 0226004150 |
| Terminal outlet for manifold base system | 146734 | 0226004201 |
| Terminal inlet for manifold base system | 146735 | 0226004200 |
| Terminal intermediate for manifold base system | 146736 | 0226004300 |

Spareparts

| | Art. No. | Type No. |
|--|----------|----------------|
| Solenoid 24 V AC, 50/60 Hz, 5 VA | 118633 | 400-517-01 |
| Solenoid 110 V AC, 50/60 Hz, 5 VA | 118634 | 400-517-07 |
| Solenoid 230 V AC, 50/60 Hz, 5 VA | 118635 | 400-517-17 |
| Solenoid 12 V DC, 5 W | 118636 | 400-517-41 |
| Solenoid 24 V DC, 5 W | 118637 | 400-517-42 |
| Solenoid 24 V AC, 50/60 Hz, 3,5 VA | 118628 | 400-514-01 |
| Solenoid 110 V AC, 50/60 Hz, 3,5 VA | 118629 | 400-514-07 |
| Solenoid 230 V AC, 50/60 Hz, 3,5 VA | 118630 | 400-514-17 |
| Solenoid 12 V DC, 2 W | 118631 | 400-514-41 |
| Solenoid 24 V DC, 2 W | 118632 | 400-514-42 |
| Plug connector, standard, industrial form B, black | 117313 | 1920.9P |
| Plug connector with LED, 230 V, transparent | 117314 | 1920.9PL.17 |
| Plug connector with LED, 24 V, transparent | 117316 | 1920.9PL.42 |
| Plug connector with LED, varistor 230 V, transparent | 117317 | 1920.9PLV17 |
| Plug connector with LED, varistor 24 V, transparent | 117318 | 1920.9PLV42 |
| Plug connector with LED, 110 V, transparent | 151011 | 1920.9PL110 |
| Plug connector, ATEX II 2 GD, black | 123182 | 1920.9PL2GD-EX |
| Plug connector with LED, varistor 110 V, transparent | 129849 | 1920.9PLV110 |