

1

2

3

4

5

6

A

A

B

B

C

C

D

D

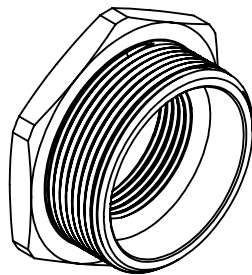
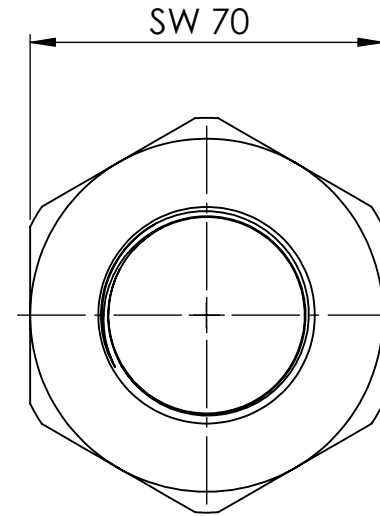
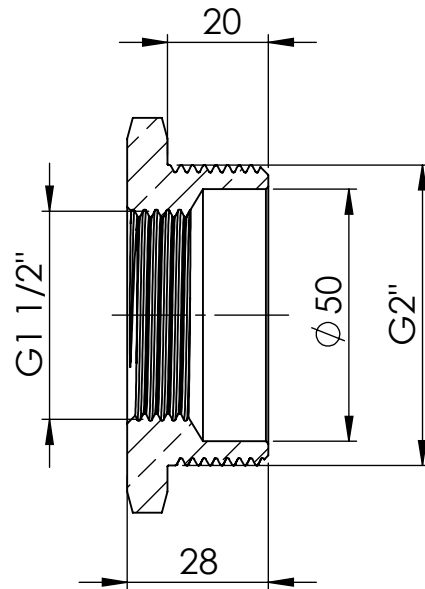

		Maßstab / Scale: 1:1.5	
		Material: CW 614N (CuZn39Pb3)	
		Benennung / Designation: Reduziernippel kurz Reducing nipple short	
		Artikelnummer / item number: 134728	Status
		Typ-Nr.: MSN251K2112	Format A4
			Version Blatt / von sheet / of 2 / 2
		 Schützenstraße 27, 72574 Bad Urach Telefon: 07125 9497-0	

1

2

3

4

5

6