

Push-in L-fitting

»metallica« series

PLUS

Art. No. 137011

Type No. 8854.012-14

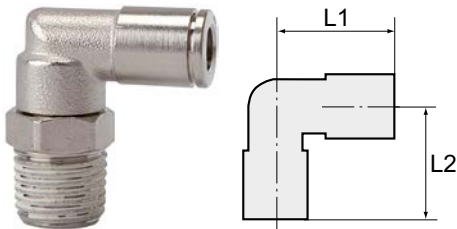

Exemplary illustration

All parts with a parallel thread are supplied with an FPM O-ring while the conical threads are coated with preCOTE 5 dispersion; all fittings in this series can thus also be used at high temperatures (medium compressed air).

Technical data

Working pressure	-0.98 - 16 bar
Operating temperature	-20 to 150 °C
Series	metallica
Material	Nickel-plated brass
Medium	Compressed air
Sealant	FKM
Sleeve	Nickel-plated brass
Clamping ring	Stainless steel
Applications	Compressed air systems, welding technology, vacuum
Recommended hose	PA and PU
Thread form	conical male thread
Version	with coated
Design	swivel type
Thread	R 1/2
For tube O.D.	14 mm
L1	32.0 mm
L2	35.5 mm
a/f	22 mm

Commercial data

Customs tariff number	74122000
Country of origin	IT
eCl@ss 5.1.4	27294201
eCl@ss 9.0	27294201
UNSPSC_Code_v190501	27131613
UNSPSC_CodeDesc_v190501	Air coupling

Material informations

REACH SVHC1 substance name	lead
CAS no. SVHC 1	7439-92-1
RoHS materials notice	RoHS compliant
REACH Info	contains SVHC substance

Dimensions

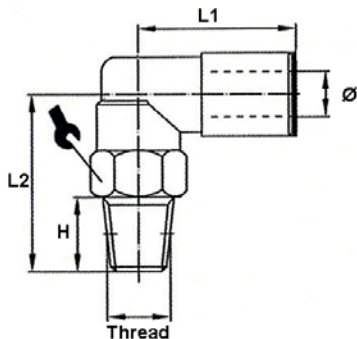

Thread	For tube O.D.	H	a/f	L1	L2
	mm	mm	mm	mm	mm
R 1/2	14	14.0	22	32.0	35.5

Accessories

	Art. No.	Type No.
Loosening tool, quick-connect fittings, hose exterior Ø 4-14 mm	121863	LW4-14
Plug nipple »metallica«, hose exterior Ø 14, nickel-plated brass	129491	8865.014
Locking plug »value line«, Supports 14 mm, nickel-plated brass	129490	58.014-E