

Pressure regulator

»SYNTESI« series

PLUS

Art. No. 139665

Type No. 5620R140

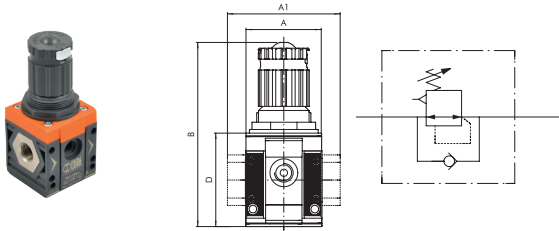

Exemplary illustration

Pressure regulator with rolling diaphragm, which has a number of advantages compared to systems with flat diaphragms:

- Larger stroke allows for wider valve aperture and therefore greater flow rate.
- Decreased dynamic and pick-up friction and therefore quicker response and enhanced sensitivity.
- Greater accuracy in maintaining the pressure setting, both with variable flow rates and different supply pressures.

Thanks to a special compensation system, the regulators keep the pressure settings virtually constant, even when the upstream pressure changes. The adjustment knob is the push-lock type with the additional possibility to secure with padlocks. There is one connection each on the front and back (G 1/8 for size 1 and G 1/4 for size 2), which can be used for pressure gauges or pressure switches or as an additional air outlet.

Pressure gauge not included in delivery!

Technical data

Series	Syntesi
Size	2
Max. input pressure	13 bar
Temperature range	-10 to 50 °C
Control range	0 - 8 bar
Input	without bushing
Output	without bushing
Front and back port thread	G 1/4
Flow rate measurement 1	at $P_1 = 10$ bar, $P_2 = 6.3$ bar and pressure drop $\Delta_p = 0.5$ bar
Flow rate 1	4700 NI/min
Flow rate measurement 2	at $P_1 = 10$ bar, $P_2 = 6.3$ bar and pressure drop $\Delta_p = 1$ bar
Flow rate 2	7600 NI/min
Medium	Compressed air or other neutral gases
Housing	Technopolymer
Sealant	NBR
Diaphragms	NBR 60 Shore (hardness) with polyester fabric insert
Spring bonnet	Technopolymer
A	60.5 mm
A1	- mm
B	139.0 mm
D	70.5 mm

Commercial data

Customs tariff number	84811099
Country of origin	IT
eCl@ss 5.1.4	37011108
eCl@ss 9.0	37011108
UNSPSC_Code_v190501	41112404
UNSPSC_CodeDesc_v190501	Pressure regulator

SYNTESI® REGULATOR

Syntesi® pressure regulator is based on the rolling diaphragm principle, which offers numerous advantages compared to systems using a flat diaphragm:

- Increased stroke, allowing wider valve aperture and hence greater flow rate.
- Decreased dynamic and pick-up friction, and hence quicker response and enhanced sensitivity.
- Greater accuracy in maintaining the pressure setting, both with both variable flow rates and different supply pressures.

The regulator includes a compensation system that keeps the pressure setting virtually constant, even when the upstream pressure changes. This is achieved mainly by the design of the valve, which is pneumatically balanced.

If the downstream pressure rises above the threshold value, the air is discharged (relief valve) until it drops below the maximum value.

A special device relieves downstream pressure rapidly when the upstream pressure drops to zero. This means the regulator can be positioned between a valve and a cylinder because the air can flow in both directions, towards the cylinder with regulated pressure, or return towards the valve during relief.

The knob is the push-lock type – once the pressure has been set, press it and it locks in position. In this position you can pull out the plate and attach two padlocks on size 1 or three padlocks on size 2 in order to avoid possible tampering. On the front and back there is a port (1/8" for size 1 and 1/4" size 2) that can be used with pressure gauges, pressure switches or as an additional regulated air intake.



UNITS

Syntesi® REGULATOR

TECHNICAL DATA	REG SY1			REG SY2			
	1/8"	1/4"	3/8"	3/8"	1/2"	3/4"	1"
Threaded port							
Max. inlet pressure	bar			13			
	MPa			1.3			
	psi			188			
Flow rate at 6.3 bar (0.63 MPa; 91 psi) ΔP 0.5 bar (0.05 MPa; 7 psi)	Nl/min	570	1600	2900	3000	4300	4700
(inlet pressure 10 bar)	scfm	20	57	103	106	152	166
Flow rate at 6.3 bar (0.63 MPa; 91 psi) ΔP 1 bar (0.1 MPa; 14 psi)	Nl/min	1200	2800	3350	5300	7400	7600
(inlet pressure 10 bar)	scfm	42	99	119	188	261	267
Relief valve flow rate at 6.3 bar (0.63 MPa; 91 psi)	Nl/min	70			100		
	scfm	2.5			3.5		
Min/max temperature at 10 bar; 1 MPa; 145 psi	°C	From -10 to +50			From -10 to +50		
Full outflow with zero inlet pressure		Included					
Padlockable knob		Included					
Upstream pressure compensation		Included, via balanced valve					
Weight	g	193	188	179	546	519	515 503
Fluid		Compressed air or other inert gases					
Mounting position		In any position					
Additional air take-off, for pressure gauges or fittings		1/8", front and rear			1/4", front and rear		
Additional air take-off flow rate at 6.3 bar	Nl/min	500			1400		
(0.63 MPa; 91 psi) ΔP 1 bar (0.1 MPa; 14 psi)	scfm	18			50		
Wall fixing screws		No. 2 M4 screws			No. 2 M5 screws		
Notes on use		The pressure must always be set upwards. For increased sensitivity, use a pressure regulator with a rated pressure as close as possible to the required value. On request version without overpressure exhaust					

COMPONENTS

- ① Technopolymer adjusting knob
- ② Technopolymer bell
- ③ Steel adjusting spring (with Geomet[®] treatment for anti-corrosion version)
- ④ Technopolymer flange
- ⑤ Rolling diaphragm
- ⑥ IN/OUT bushing made of OT58 nickel-plated brass or passivated aluminium for 3/4" - 1"
- ⑦ Technopolymer regulator body
- ⑧ OT58 brass valve, with NBR vulcanized gasket
- ⑨ Stainless steel valve spring
- ⑩ Zinc-plated steel plate for knob locking (stainless steel for anti-corrosion version)
- ⑪ OT58 brass adjusting screw
- ⑫ Technopolymer ring nut
- ⑬ Technopolymer plate
- ⑭ Technopolymer rod
- ⑮ NBR o-ring gasket
- ⑯ Technopolymer plug

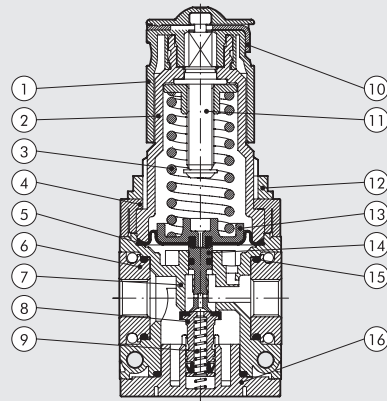

FLOW CHARTS

REG Syntesi[®] SY1 1/8"

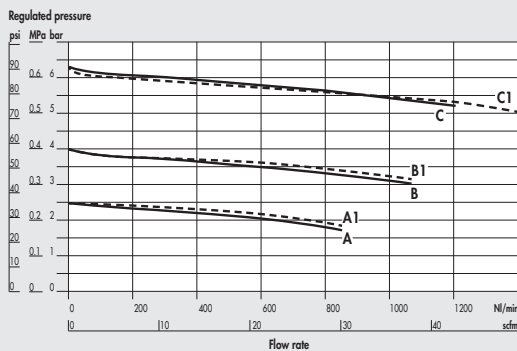

REG Syntesi[®] SY1 1/4"

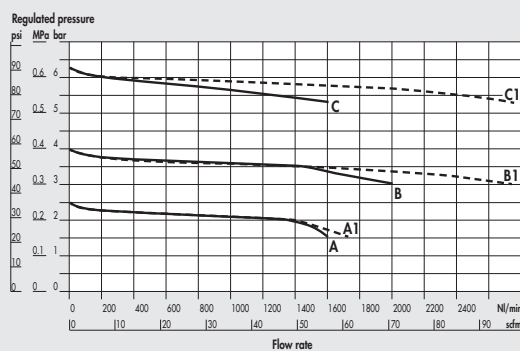

REG Syntesi[®] SY1 3/8"

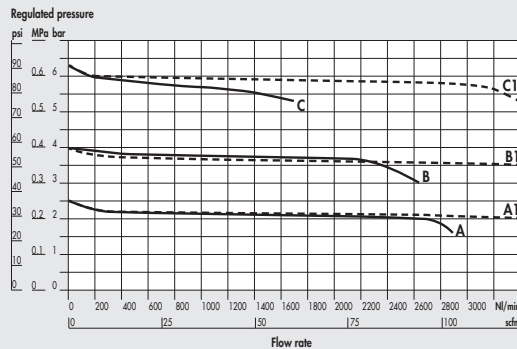

REG Syntesi[®] SY2 3/8"

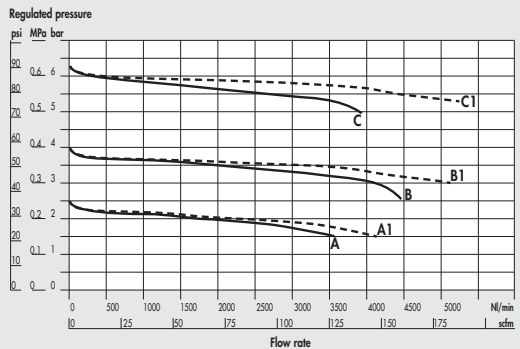

A = P In 7 bar - P Out 2.5 bar
B = P In 7 bar - P Out 4 bar

C = P In 7 bar - P Out 6.3 bar
A1 = P In 10 bar - P Out 2.5 bar

B1 = P In 10 bar - P Out 4 bar
C1 = P In 10 bar - P Out 6.3 bar

UNITS

Syntesi[®] REGULATOR

REG Syntesi® SY2 1/2"

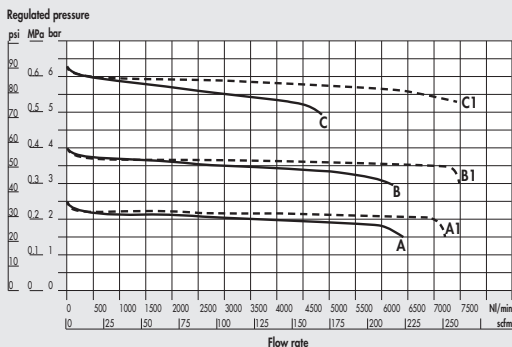

REG Syntesi® SY2 3/4" - 1"

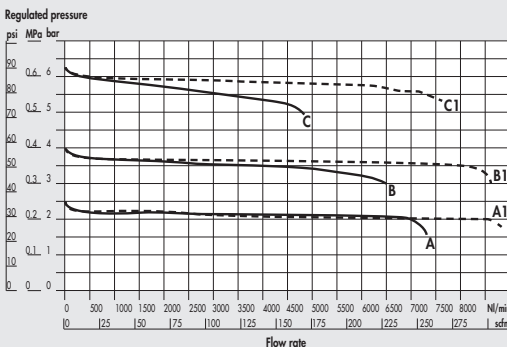

A = P In 7 bar - P Out 2.5 bar C = P In 7 bar - P Out 6.3 bar B1 = P In 10 bar - P Out 4 bar
 B = P In 7 bar - P Out 4 bar A1 = P In 10 bar - P Out 2.5 bar C1 = P In 10 bar - P Out 6.3 bar

DIMENSIONS

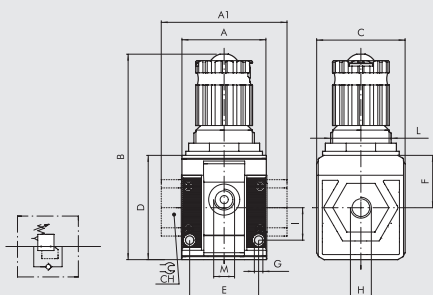

	SIZE 1			SIZE 2		
	1/8"	1/4"	3/8"	3/8"	1/2"	3/4"
H (threaded port)	1/8"	1/4"	3/8"	3/8"	1/2"	3/4"
A	42	-	-	-	-	60.5
A1	-	-	44	-	-	95
B	102	-	-	-	-	139
C	44	-	-	-	-	61
CH	-	-	-	-	32	36
D	51.5	-	-	-	-	70.5
E	33.5	-	-	-	-	47.5
F	25.8	-	-	-	-	38.2
G	Hole for M4 screws			Hole for M5 screws		
I	16	-	-	-	-	22.5
L	M30x1.5			M38x2		
M (pressure gauge port or air takes-off)	1/8"			1/4"		

KEY TO CODES

56	1	1	R	14	1
SYNTESI	SIZE	THREADED INPUT CONNECTION	ELEMENT	SETTING RANGE	THREADED OUTPUT CONNECTION
56 Syntesi 5X Syntesi anti-corrosion	1 Size 1 2 Size 2	0 Without bushing 1 1/8" port 2 1/4" port 3 3/8" port 0 Without bushing 3 3/8" port 4 1/2" port 5 3/4" port 6 1" port	R Pressure regulator	● 10 0 to 2 bar + 12 0 to 4 bar 14 0 to 8 bar 16 0 to 12 bar	0 Without bushing 1 1/8" port 2 1/4" port 3 3/8" port 0 Without bushing 3 3/8" port 4 1/2" port 5 3/4" port 6 1" port

● Not available in the anti-corrosion version. + Anti-corrosion version available only in size 1.

PURCHASE ORDER CODES HAVING A MORE FREQUENT USE

N.B. Besides the below mentioned codes, you can order elements composed at your will according to the key to codes.

Code	Description	Code	Description	Code	Description
Syntesi® SY1 REGULATOR		Syntesi® SY2 REGULATOR		Syntesi® SY2 REGULATOR	
5610R140	REG SY1 08 without bushings	5620R140	REG SY2 08 without bushings	5626R146	REG SY2 1 08
5610R160	REG SY1 012 without bushings	5620R160	REG SY2 012 without bushings	5626R166	REG SY2 1 012
5611R141	REG SY1 1/8 08	5623R143	REG SY2 3/8 08	NOTE	
5611R161	REG SY1 1/8 012	5623R163	REG SY2 3/8 012	Anti-corrosion version	
5612R142	REG SY1 1/4 08	5624R144	REG SY2 1/2 08	5X-----	
5612R162	REG SY1 1/4 012	5624R164	REG SY2 1/2 012	Example	
5613R143	REG SY1 3/8 08	5625R145	REG SY2 3/4 08	5X11R141	REG SY1 1/8 08 anti-corrosion
5613R163	REG SY1 3/8 012	5625R165	REG SY2 3/4 012		

UNITS

Syntesi® REGULATOR

GENERAL TECHNICAL DATA SYNTESI®

Syntesi® is an important milestone achieved by Metal Work, the result of thirty years' experience producing air-treatment units. It has been studied in minute detail to obtain the best possible performance in a reduced space and with limited weight. The capacity is much higher than that of other units of the same size.

This modular unit features a very simple yet effective system that requires no brackets, stay bolts or yoke for assembling the elements.

The basic version of Syntesi® incorporates numerous functions that are not provided or are only optional with traditional units. Examples are padlockable knobs, additional pneumatic ports on the front and back, flow options from left to right or vice versa, regulators with compensation system - which are accurate even when the upstream pressure changes, with rapid downstream pressure relief - full indelible marking, automatic condensate drain even in size 1, and 360° visual inspection of oil and condensate levels. The basic materials, technopolymer and nickel-plated brass have excellent corrosion resistance. An anti-corrosion version is available with stainless steel components (screws, plates) or Geomet®-treated ones (regulator springs).



UNITS

GENERAL TECHNICAL DATA Syntesi®

TECHNICAL DATA	SIZE 1			SIZE 2			
	1/8"	1/4"	3/8"	3/8"	1/2"	3/4"	1"
Threaded port							
Max. input pressure	bar	15			13		
	MPa	1.5			1.3		
	psi	217			188		
Flow rate	See catalogue of the various elements						
Min/max temperature at 10 bar; 1 MPa; 145 psi	°C from -10 to +50			°C from -10 to +50			
Padlockable knob	The knobs of the regulators, filter regulators and standard sectioning valves can all be padlocked						
Fluid	Compressed air or other inert gases						
Mounting position	See catalogue of the various elements						
Direction of flow	Flow options right to left or vice versa						
Additional air take-off, for pressure gauges or fittings	1/8", front and rear, on all modules			1/4", front and rear, on all modules			
Wall fixing screws	No. 2 M4 screws			No. 2 M5 screws			
Certification for potentially explosive atmosphere according to ATEX 2014/34/EU rule	 II 3G Ex h IIC T5 Gc -10°C < Ta < 50°C II 3D Ex h IIIC T100 °C Dc						

ANTI-CORROSION VERSION

- Differences compared to the standard version:
- stainless steel screws
 - stainless steel plate for R, FR, V3V knobs
 - Geomet®-treated regulator spring and filter-regulator

FIXING TO FRONT PORTS



Do not use a spanner for fixing taper threaded elements to the front ports. Mount by hand and apply a liquid sealant (not teflon®).

ROTARY BUSHINGS



3/4" and 1" bushings in Size 2 rotate freely to facilitate assembly operations.

LASER MARKING



The following is marked indelibly on the body:

- Metal Work trademark
- Code
- Maximum pressure and temperature
- Degree of filtration or pressure range, where relevant
- Week and year of manufacture
- ATEX category
- Made in Italy

MOUNTING OPTIONS

On the wall, using two screws



On a panel



Using knob bracket



Using a bracket



The bracket can be secured in any position, and the fittings can be mounted on the pressure gauge air intake at the back of the unit.

On a DIN EN50022 bar with the opposite adaptor



UNITS

GENERAL TECHNICAL DATA Synthesi®

MODULARITY AND FLEXIBILITY

UNITS

GENERAL TECHNICAL DATA Syntesi®



The various elements of Syntesi® A can be connected to the air feed and delivery circuit using pneumatic nickel brass or passivated aluminium ports® and can be fixed together using nipples®.

The nipples and ports are easy to remove by unscrewing the two front screws®. This solution has numerous advantages:

- Reduced overall dimensions.
- Free composition of multiple elements, without the need for brackets, stay bolts or yoke.
- The threads for the fittings are metallic, allowing high tightening torques, also for tapered threads.
- Maximum flexibility: a unit can be transformed at any time by adding an element or replacing a port with another one, e.g. 1/4" instead of 1/8".
- The air intake port can be the same or different from the outlet port, as desired.

Standard Syntesi® ports are: 1/8", 1/4", 3/8" for size 1; 3/8", 1/2", 3/4", 1" for size 2.

It may be necessary to use a vice to insert the bushes into size 2.

The nipples have different functions:

- Nipple® joins two elements of the same size together.
- Size adaptor® can be used to connect an element in the Syntesi® 2 series with one in the Syntesi® 1 series.
- The 90° adaptor® can be used to connect two 90° angled elements. For example, it can help directing the regulator knob or the control knob of a sectioning valve towards the user.
- The two-way air intake® is a simple and cost-effective system which, besides connecting two elements together, has 2 opposing threaded air intakes.
- The adaptor for Regtronic® can be used to fix the Regtronic 1/4" proportional valve to a Syntesi® size 1 element.

Additional ports®. On the front and back of ALL Syntesi® elements there is a port (1/8" for size 1, 1/4" for size 2) that can be used for pressure gauges®, pressure switches® or, given the high flow rate, as additional air take-off®. These ports are downstream of the element, so, for example, a regulator port can supply air at a set pressure or a filter port can supply filtered air (not valid for activated carbon filter and depurator).

Wall fixing. Only two through screws® are needed. No bulky brackets or additional flanges are required. The bracket® can be used to separate the unit from the fixing wall, e.g. to mount a fitting to the rear port.

Fixing on a DIN EN50022 bar. Can be done using the bracket kit®.

Regulator fixing bracket®. Regulators and filter-regulators can also be fixed using a steel bracket® that embraces the bell.

Padlockable knob®. The knobs of regulators, filter-regulator and sectioning valves can all be padlocked. The steel plate is included in the supply. You can insert up to two 3 mm diameter padlocks® on size 1 and three padlocks on size 2. As an alternative, the sectioning valve can have a steel plate suitable for a single 6 mm diameter padlock.

Safety valve®. The unit can incorporate a series 70 SAFE AIR® safety valve.

Flowmeter series FLUX 1-2®. The unit can incorporate a series FLUX 1 or FLUX 2 flow meter.

C1

SYNTESI® KEY TO CODES

KEY TO CODES SINGLE ELEMENT

56	1	1	F	10	1
SYNTESI	SIZE	THREADED INPUT CONNECTION	ELEMENT	TYPE	THREADED OUTPUT CONNECTION
56 Syntesi 5X Syntesi anti-corrosion	1 Size 1	0 Without bushing 1 1/8" port 2 1/4" port 3 3/8" port	F Filter D Depurator C Active carbon filter R Pressure regulator B Filter-regulator L Lubricator ● V Shut off valve ▲ A Progressive starter ▲ S Pressure switches P Air take-off	Varies from element to element	0 Without bushing 1 1/8" port 2 1/4" port 3 3/8" port
	2 Size 2	0 Without bushing 3 3/8" port 4 1/2" port 5 3/4" port 6 1" port			0 Without bushing 3 3/8" port 4 1/2" port 5 3/4" port 6 1" port

- The anti-corrosion version of this element is only available with manual actuation.
- ▲ Not available in the anti-corrosion version.

KEY TO CODES UNIT COMPOSED OF TWO OR THREE ELEMENTS

56	1	1	V	10	B	24	L	10	1
SYNTESI	SIZE	THREADED INPUT CONNECTION	ELEMENT 1	TYPE	ELEMENT 2	TYPE	ELEMENT 3	TYPE	THREADED OUTPUT CONNECTION
56 Syntesi 5X Syntesi anti-corrosion	1 Size 1	1 1/8" port 2 1/4" port 3 3/8" port	F Filter D Depurator C Active carbon filter R Pressure regulator B Filter-regulator L Lubricator ● V Shut off valve ▲ A Progressive starter ▲ S Pressure switches P Air Take-off	Varies from element to element	F Filter D Depurator C Active carbon filter R Pressure regulator B Filter-regulator L Lubricator ● V Shut off valve ▲ A Progressive starter ▲ S Pressure switches P Air Take-off	Varies from element to element	F Filter D Depurator C Active carbon filter R Pressure regulator B Filter-regulator L Lubricator ● V Shut off valve ▲ A Progressive starter ▲ S Pressure switches P Air Take-off	Varies from element to element	1 1/8" port 2 1/4" port 3 3/8" port 3 3/8" port 4 1/2" port 5 3/4" port 6 1" port
	2 Size 2	3 3/8" port 4 1/2" port 5 3/4" port 6 1" port							

- The anti-corrosion version of this element is only available with manual actuation.
- ▲ Not available in the anti-corrosion version.

UNITS

SYNTESI® KEY TO CODES

C1.8

Accessories

	Art. No.	Type No.
Neck bracket, for size 2, and others	145469	9400701
Mounting bracket, size 2, standard and anti-corr.	145659	9200717X
Adapter for DIN rail, size 1 and size 2	145660	9200718X
Pressure gauge, G1/4 rear centric, 0-12 bar, Ø63mm	145474	9900101
Adapter for pressure gauges, G 1/4 ET, G 1/8 IT	145477	9210005
Threaded port bushing, size 2, G 3/8	144691	9210011
Threaded port bushing, size 2, G 1/2	144692	9210012
Threaded port bushing, size 2, G 3/4	144693	9210013
Threaded port bushing, size 2, G 1	144694	9210014
Connecting nipple kit, size 2	144696	9210010
Connecting element 90°, size 2	145503	9210019
Size adapter, size 1 - size 2, incl. 4 screws	145504	9210006
Fastening screw, size 2	145508	9210031
Padlock	145509	9062401

Spareparts

	Art. No.	Type No.
Spring, size 2, 0 - 8 bar	145639	9210197
Regulator cap (bell), size 2, 0 - 8 bar	145647	9210222
Valve poppet for pressure regulator, size 2	145650	9210230