

# Air take-off

»SYNTESI« series

**PLUS**

Art. No. 144901

Type No. 5626P206

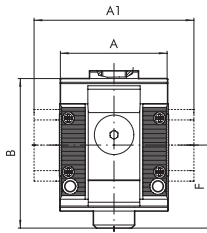

Exemplary illustration

Air take-off for mounting between two »SYNTESI« modules.

The 2-way version, made of nickel-plated brass, has two threaded ports, one facing upwards and one downwards.

In the 4-way version, made of technopolymer, there is a threaded connection on each side. Thus, a total of four air outlets are available.

## Technical data

Series	Syntesi
Size	2
Max. input pressure	13 bar
Temperature range	-10 to 50 °C
Input	G 1
Output	G 1
Outlet	1 x G 3/8, 3 x G 1/4
Flow rate measurement	$P_2 = 6.3$ bar and pressure drop $\Delta_p = 1$ bar
Flow rate	1500 - 4500 l/min
Medium	Compressed air or other neutral gases
Housing	Technopolymer
A	60.5 mm
A1	95,0 mm
B	81.0 mm
F	42.7 mm

## Commercial data

Customs tariff number	84818099
Country of origin	IT
eCl@ss 5.1.4	27294206
eCl@ss 9.0	27294206
UNSPSC_Code_v190501	27131611
UNSPSC_CodeDesc_v190501	Air manifolds

# SYNTESI® AIR TAKE-OFF



The air take-off is a connecting element that is mounted between two Syntesi® modules. The 2-way version, made of metal and having restrained dimensions, has a threaded port upwards and one downwards. The 4-way version, in technopolymer, has a threaded port on each side. This gives or four additional air outlets for use as required. All Syntesi® modules come with two threaded ports, one on the front and one on the back, for use as air take-off.



TECHNICAL DATA	AIR TAKE-OFF, SY1		AIR TAKE-OFF, SY2	
	PA 2-way	PA 4-way	PA 2-way	PA 4-way
Version	1550	500 - 2000	7000	1500 - 4500
Flow rate of the air take-off at 6.3 bar (0.63 MPa; 91 psi) ΔP 1 bar (0.1 MPa; 14 psi) NI/min	55	18 - 71	248	53 - 160
Maximum pressure	15		13	
	bar		bar	
	1.5		1.3	
	MPa		MPa	
	217		188	
	psi		psi	
Min/Max temperature at 10 bar; 1 MPa; 145 psi	From -10 to 50		From -10 to 50	
Weight	62	100	75	306
Fluid	Compressed air or other inert gases			

UNITS

Syntesi® AIR TAKE-OFF

## DIMENSIONS AND ORDERING CODES OF THE 2-WAY VERSION

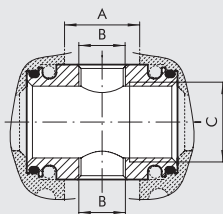

Code	Description	A	B	C
5610P100	PA SY1	15.5	1/8"	3/8"
5620P100	PA SY2	27	3/8"	1/2"

**DIMENSIONS 4-WAY-VERSION**

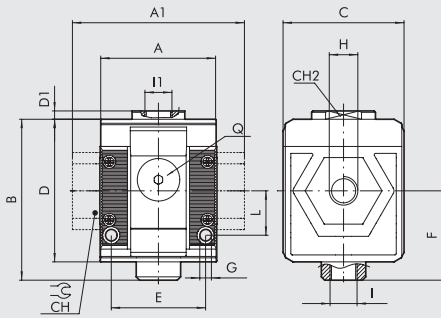

	SIZE 1			SIZE 2			
	1/8"	1/4"	3/8"	3/8"	1/2"	3/4"	1"
H (threaded port)	1/8"	1/4"	3/8"	3/8"	1/2"	3/4"	1"
A	42			60.5			
A1	-	-	44	-	-	95	95
B	58			81			
C	44			61			
CH	-	-	-	-	-	32	36
CH2	19			-			
D	51.5			70.5			
D1	3			-			
E	33.5			47.5			
F	32.2			42.7			
G	Hole for M4 screws			Hole for M5 screws			
I	1/8"			1/4"			
I1	1/4"			3/8"			
L	16			22.5			
Q (no. 2 add. air takes-off)	1/8"			1/4"			

**KEY TO CODE FOR 4-WAY VERSION**

56	1	1	P	20	1
SYNTESI	SIZE	THREADED INPUT CONNECTION	ELEMENT	TYPE	THREADED OUTPUT CONNECTION
56 Syntesi 5X Syntesi anti-corrosion	1 Size 1  2 Size 2	0 Without bushing 1 1/8" port 2 1/4" port 3 3/8" port  0 Without bushing 3 3/8" port 4 1/2" port 5 3/4" port 6 1" port	P Air take-off	20 4-way	0 Without bushing 1 1/8" port 2 1/4" port 3 3/8" port  0 Without bushing 3 3/8" port 4 1/2" port 5 3/4" port 6 1" port

N.B. Besides the below mentioned codes, you can order elements composed at your will according to the key to codes.

**PURCHASE ORDER CODES HAVING A MORE FREQUENT USE CODES**

Code	Description	Code	Description	NOTE
<b>AIR INTAKE, 2-way version</b>		<b>AIR INTAKE, 4-way version</b>		<b>Anti-corrosion version</b> <b>5X</b> ----- <b>Example</b> <b>5X11P201</b> PA 4-way SY1 1/8 anti-corrosion
5610P100	PA SY1	5610P200	PA 4-way SY1 without bushing	
5620P100	PA SY2	5611P201	PA 4-way SY1 1/8	
		5612P202	PA 4-way SY1 1/4	
		5613P203	PA 4-way SY1 3/8	
		5620P200	PA 4-way SY2 without bushing	
		5623P203	PA 4-way SY2 3/8	
		5624P204	PA 4-way SY2 1/2	
		5625P205	PA 4-way SY2 3/4	
		5626P206	PA 4-way SY2 1	

UNITS

Syntesi® AIR TAKE-OFF

## GENERAL TECHNICAL DATA SYNTESI®

Syntesi® is an important milestone achieved by Metal Work, the result of thirty years' experience producing air-treatment units. It has been studied in minute detail to obtain the best possible performance in a reduced space and with limited weight. The capacity is much higher than that of other units of the same size.

This modular unit features a very simple yet effective system that requires no brackets, stay bolts or yoke for assembling the elements.

The basic version of Syntesi® incorporates numerous functions that are not provided or are only optional with traditional units. Examples are padlockable knobs, additional pneumatic ports on the front and back, flow options from left to right or vice versa, regulators with compensation system - which are accurate even when the upstream pressure changes, with rapid downstream pressure relief - full indelible marking, automatic condensate drain even in size 1, and 360° visual inspection of oil and condensate levels. The basic materials, technopolymer and nickel-plated brass have excellent corrosion resistance. An anti-corrosion version is available with stainless steel components (screws, plates) or Geomet®-treated ones (regulator springs).



UNITS

GENERAL TECHNICAL DATA Syntesi®

TECHNICAL DATA	SIZE 1			SIZE 2			
	1/8"	1/4"	3/8"	3/8"	1/2"	3/4"	1"
Threaded port							
Max. input pressure	bar	15				13	
	MPa	1.5				1.3	
	psi	217				188	
Flow rate	See catalogue of the various elements						
Min/max temperature at 10 bar; 1 MPa; 145 psi	°C from -10 to +50			°C from -10 to +50			
Padlockable knob	The knobs of the regulators, filter regulators and standard sectioning valves can all be padlocked						
Fluid	Compressed air or other inert gases						
Mounting position	See catalogue of the various elements						
Direction of flow	Flow options right to left or vice versa						
Additional air take-off, for pressure gauges or fittings	1/8", front and rear, on all modules			1/4", front and rear, on all modules			
Wall fixing screws	No. 2 M4 screws			No. 2 M5 screws			
Certification for potentially explosive atmosphere according to ATEX 2014/34/EU rule	 II 3G Ex h IIC T5 Gc -10°C < Ta < 50°C II 3D Ex h IIIC T100 °C Dc						

### ANTI-CORROSION VERSION

- Differences compared to the standard version:
- stainless steel screws
  - stainless steel plate for R, FR, V3V knobs
  - Geomet®-treated regulator spring and filter-regulator

**FIXING TO FRONT PORTS**



Do not use a spanner for fixing taper threaded elements to the front ports. Mount by hand and apply a liquid sealant (not teflon®).

**ROTARY BUSHINGS**



3/4" and 1" bushings in Size 2 rotate freely to facilitate assembly operations.

**LASER MARKING**

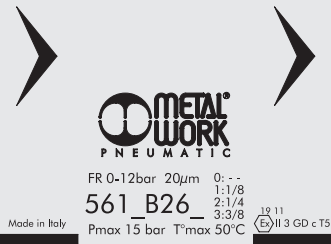

The following is marked indelibly on the body:

- Metal Work trademark
- Code
- Maximum pressure and temperature
- Degree of filtration or pressure range, where relevant
- Week and year of manufacture
- ATEX category
- Made in Italy

**MOUNTING OPTIONS**

On the wall, using two screws



On a panel



Using knob bracket

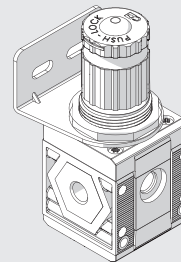

Using a bracket



The bracket can be secured in any position, and the fittings can be mounted on the pressure gauge air intake at the back of the unit.

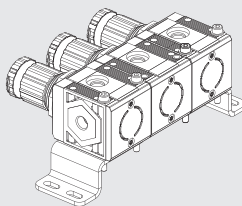

On a DIN EN50022 bar with the opposite adaptor

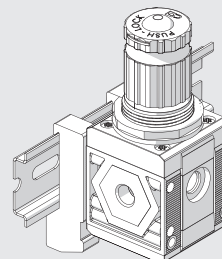

MODULARITY AND FLEXIBILITY

UNITS

GENERAL TECHNICAL DATA Syntesi®



The various elements of Syntesi® A can be connected to the air feed and delivery circuit using pneumatic nickel brass or passivated aluminium ports® and can be fixed together using nipples®.

The nipples and ports are easy to remove by unscrewing the two front screws®. This solution has numerous advantages:

- Reduced overall dimensions.
- Free composition of multiple elements, without the need for brackets, stay bolts or yoke.
- The threads for the fittings are metallic, allowing high tightening torques, also for tapered threads.
- Maximum flexibility: a unit can be transformed at any time by adding an element or replacing a port with another one, e.g. 1/4" instead of 1/8".
- The air intake port can be the same or different from the outlet port, as desired.

Standard Syntesi® ports are: 1/8", 1/4", 3/8" for size 1; 3/8", 1/2", 3/4", 1" for size 2.

It may be necessary to use a vice to insert the bushes into size 2.

The nipples have different functions:

- Nipple® joins two elements of the same size together.
- Size adaptor® can be used to connect an element in the Syntesi® 2 series with one in the Syntesi® 1 series.
- The 90° adaptor® can be used to connect two 90° angled elements. For example, it can help directing the regulator knob or the control knob of a sectioning valve towards the user.
- The two-way air intake® is a simple and cost-effective system which, besides connecting two elements together, has 2 opposing threaded air intakes.
- The adaptor for Regtronic® can be used to fix the Regtronic 1/4" proportional valve to a Syntesi® size 1 element.

**Additional ports®.** On the front and back of ALL Syntesi® elements there is a port (1/8" for size 1, 1/4" for size 2) that can be used for pressure gauges®, pressure switches® or, given the high flow rate, as additional air take-off®. These ports are downstream of the element, so, for example, a regulator port can supply air at a set pressure or a filter port can supply filtered air (not valid for activated carbon filter and depurator).

**Wall fixing.** Only two through screws® are needed. No bulky brackets or additional flanges are required. The bracket® can be used to separate the unit from the fixing wall, e.g. to mount a fitting to the rear port.

**Fixing on a DIN EN50022 bar.** Can be done using the bracket kit®.

**Regulator fixing bracket®.** Regulators and filter-regulators can also be fixed using a steel bracket® that embraces the bell.

**Padlockable knob®.** The knobs of regulators, filter-regulator and sectioning valves can all be padlocked. The steel plate is included in the supply. You can insert up to two 3 mm diameter padlocks® on size 1 and three padlocks on size 2. As an alternative, the sectioning valve can have a steel plate suitable for a single 6 mm diameter padlock.

**Safety valve®.** The unit can incorporate a series 70 SAFE AIR® safety valve.

**Flowmeter series FLUX 1-2®.** The unit can incorporate a series FLUX 1 or FLUX 2 flow meter.



C1

# SYNTESI® KEY TO CODES

## KEY TO CODES SINGLE ELEMENT

56	1	1	F	10	1
SYNTESI	SIZE	THREADED INPUT CONNECTION	ELEMENT	TYPE	THREADED OUTPUT CONNECTION
56 Syntesi 5X Syntesi anti-corrosion	1 Size 1	0 Without bushing 1 1/8" port 2 1/4" port 3 3/8" port	F Filter D Depurator C Active carbon filter R Pressure regulator B Filter-regulator L Lubricator ● V Shut off valve ▲ A Progressive starter ▲ S Pressure switches P Air take-off	Varies from element to element	0 Without bushing 1 1/8" port 2 1/4" port 3 3/8" port
	2 Size 2	0 Without bushing 3 3/8" port 4 1/2" port 5 3/4" port 6 1" port			0 Without bushing 3 3/8" port 4 1/2" port 5 3/4" port 6 1" port

- The anti-corrosion version of this element is only available with manual actuation.
- ▲ Not available in the anti-corrosion version.

## KEY TO CODES UNIT COMPOSED OF TWO OR THREE ELEMENTS

56	1	1	V	10	B	24	L	10	1
SYNTESI	SIZE	THREADED INPUT CONNECTION	ELEMENT 1	TYPE	ELEMENT 2	TYPE	ELEMENT 3	TYPE	THREADED OUTPUT CONNECTION
56 Syntesi 5X Syntesi anti-corrosion	1 Size 1	1 1/8" port 2 1/4" port 3 3/8" port	F Filter D Depurator C Active carbon filter R Pressure regulator B Filter-regulator L Lubricator ● V Shut off valve ▲ A Progressive starter ▲ S Pressure switches P Air Take-off	Varies from element to element	F Filter D Depurator C Active carbon filter R Pressure regulator B Filter-regulator L Lubricator ● V Shut off valve ▲ A Progressive starter ▲ S Pressure switches P Air Take-off	Varies from element to element	F Filter D Depurator C Active carbon filter R Pressure regulator B Filter-regulator L Lubricator ● V Shut off valve ▲ A Progressive starter ▲ S Pressure switches P Air Take-off	Varies from element to element	1 1/8" port 2 1/4" port 3 3/8" port 3 3/8" port 4 1/2" port 5 3/4" port 6 1" port
	2 Size 2	3 3/8" port 4 1/2" port 5 3/4" port 6 1" port							

- The anti-corrosion version of this element is only available with manual actuation.
- ▲ Not available in the anti-corrosion version.

UNITS

SYNTESI® KEY TO CODES

C1.8

## Accessories

	<b>Art. No.</b>	<b>Type No.</b>
Mounting bracket, size 2, standard and anti-corr.	145659	9200717X
Adapter for DIN rail, size 1 and size 2	145660	9200718X
Connecting nipple kit, size 2	144696	9210010
Connecting element 90°, size 2	145503	9210019
Size adapter, size 1 - size 2, incl. 4 screws	145504	9210006
Fastening screw, size 2	145508	9210031

## Spareparts

	<b>Art. No.</b>	<b>Type No.</b>
Threaded port bushing, size 2, G 1	144694	9210014