

## Service unit

»SYNTESI« series

**PLUS**

Art. No. 145026

Type No. 5611V10B46L101

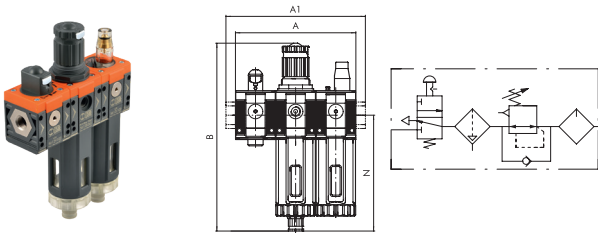

Exemplary illustration

Three-part maintenance units consisting of shut-off valve, filter regulator and lubricator of the »SYNTESI« series. For all information on the relevant properties, please refer to the data sheets of the individual components.

The shut-off valve is the manual version with 3.5 mm hole for padlocks.

Silencer not included in delivery!

Pressure gauge not included in delivery!

## Technical data

|   |   |
|---|---|
| Series  | Syntesi   |
| Size  | 1   |
| Max. input pressure                             | 10 bar  |
| Temperature range                               | -10 to 50 °C  |
| Control range                                   | 0 - 10 bar  |
| Input   | G 1/8   |
| Output  | G 1/8   |
| Front and back port thread                      | G 1/8   |
| Flow rate measurement 1                         | at $P_1 = 10$ bar, $P_2 = 6.3$ bar and pressure drop $\Delta_p = 0.5$ bar |
| Flow rate 1                                     | 250 NI/min  |
| Flow rate measurement 2                         | at $P_1 = 10$ bar, $P_2 = 6.3$ bar and pressure drop $\Delta_p = 1$ bar   |
| Flow rate 2                                     | 1050 NI/min   |
| Filter rating                                   | 5 $\mu$ m   |
| Condensate drain                                | RA fully automatic  |
| Output air purity class according to ISO 8573-1 | 3.7.-   |
| Medium  | Compressed air or other neutral gases                                     |
| Housing   | Technopolymer   |
| Sealant   | NBR   |
| Diaphragms                                      | NBR 60 Shore (hardness) with polyester fabric insert                      |
| Bowl  | Technopolymer   |
| Sight dome                                      | Brass   |
| Spring bonnet                                   | Technopolymer   |
| A   | 126.0 mm  |
| A1  | - mm  |
| B   | 202.0 mm  |
| N   | 126.2 mm  |

## Commercial data

|                         |                       |
|-------------------------|-----------------------|
| Customs tariff number   | 84811005              |
| Country of origin       | IT                    |
| eCl@ss 5.1.4            | 27292890              |
| eCl@ss 9.0              | 27292890              |
| UNSPSC_Code_v190501     | 27131604              |
| UNSPSC_CodeDesc_v190501 | Pneumatic lubricators |

C1

## V3V + FR + LUB SYNTESI®

For full details and list of components refer to the sections about shut-off valve, filter-regulator and lubricator.



UNITS

V3V + FR + LUB Syntesi®

| TECHNICAL DATA   | V3V + FR + LUB SY1  |      |                                    | V3V + FR + LUB SY2   |      |      |    |
|--|---|------|------------------------------------|----------------------|------|------|----|
|  | 1/8"  | 1/4" | 3/8"                               | 3/8"                 | 1/2" | 3/4" | 1" |
| Threaded port  | 5 (yellow) - output air purity class ISO8573-1: 3.7.-<br>20 (white) - output air purity class ISO8573-1: 4.7.-<br>50 (blue) - output air purity class ISO8573-1: 5.7.-  |      |                                    |                      |      |      |    |
| Degree of filtration   | µm  |      |                                    |                      |      |      |    |
| Max. inlet pressure  | bar   |      | MPa                                |                      |      |      |    |
|  | 15  |      | 1.3                                |                      |      |      |    |
|  | psi   |      | 1.3                                |                      |      |      |    |
|  | 217   |      | 188                                |                      |      |      |    |
| Flow rate at 6.3 bar (0.63 MPa; 91 psi) ΔP 0.5 bar (0.05 MPa; 7 psi) | NL/min  |      | scfm                               |                      |      |      |    |
| (P In=10 bar)  | 250   |      | 1200                               |                      |      |      |    |
|  | scfm  |      | 42.5                               |                      |      |      |    |
|  | 9   |      | 4000                               |                      |      |      |    |
| Flow rate at 6.3 bar (0.63 MPa; 91 psi) ΔP 1 bar (0.1 MPa; 14 psi)   | NL/min  |      | scfm                               |                      |      |      |    |
| (P In=10 bar)  | 1050  |      | 141.5                              |                      |      |      |    |
|  | scfm  |      | 37                                 |                      |      |      |    |
| Relief valve flow rate at 6.3 bar (0.63 MPa; 91 psi)                 | NL/min  |      | scfm                               |                      |      |      |    |
|  | 70  |      | 100                                |                      |      |      |    |
|  | scfm  |      | 2.5                                |                      |      |      |    |
|  | 2.5   |      | 3.5                                |                      |      |      |    |
| Min/max temperature at 10 bar; 1 MPa; 145 psi                        | °C  |      |                                    | °C                   |      |      |    |
|  | From -10 to +50   |      |                                    | From -10 to +50      |      |      |    |
| Full outflow with zero inlet pressure                                | Included  |      |                                    | Included             |      |      |    |
| Drain flow rate at 6.3 bar (0.63 MPa; 91 psi)                        | NL/min  |      | scfm                               |                      |      |      |    |
|  | 500   |      | 2000                               |                      |      |      |    |
|  | scfm  |      | 18                                 |                      |      |      |    |
|  | 18  |      | 71                                 |                      |      |      |    |
| Padlockable knob   | Included with both V3V and regulator  |      |                                    |                      |      |      |    |
| Upstream pressure compensation                                       | Included, via balanced valve  |      |                                    |                      |      |      |    |
| Weight   | g   |      | g                                  |                      |      |      |    |
|  | 598   |      | 1479                               |                      |      |      |    |
|  | 593   |      | 1452                               |                      |      |      |    |
|  | 584   |      | 1448                               |                      |      |      |    |
|  | 1479  |      | 1436                               |                      |      |      |    |
| Fluid  | Compressed air or other inert gases   |      |                                    |                      |      |      |    |
| Mounting position  | Vertical  |      |                                    | Vertical             |      |      |    |
| Additional air take-off, for pressure gauges or fittings             | 1/8", front and rear  |      |                                    | 1/4", front and rear |      |      |    |
| Additional air take-off flow rate at 6.3 bar                         | NL/min  |      | scfm                               |                      |      |      |    |
| (0.63 MPa; 91 psi) ΔP 1 bar (0.1 MPa; 14 psi)                        | 500 (V3V) - 500 (FR) - 450 (LUB)  |      | 1500 (V3V) - 1400 (FR) - 800 (LUB) |                      |      |      |    |
|  | scfm  |      | 53 (V3V) - 49.5 (FR) - 28 (LUB)    |                      |      |      |    |
| Filter bowl capacity   | cm <sup>3</sup>   |      | cm <sup>3</sup>                    |                      |      |      |    |
|  | 30  |      | 70                                 |                      |      |      |    |
| Quantity of filled oil   | cm <sup>3</sup>   |      | cm <sup>3</sup>                    |                      |      |      |    |
|  | 60  |      | 130                                |                      |      |      |    |
| Condensate drain   | RMSA: drain with manual condensate discharge and automatic discharge at zero pressure<br>RA: automatic drain with condensate discharge, independent of pressure and flow rate.<br>Version conveys the draining by inserting the pipe having internal diameter 6 mm in the lower port.<br>SAC: automatic drain with condensate discharge. Operates by pressure drop - requires variable air take-offs.<br>Note: the maximum input pressure for the RA version must not exceed 10 bar |      |                                    |                      |      |      |    |
| Recommended oils   | ISO and UNI FD22<br>(Energol HPL; Spinesso; Mobil DTE; Tellus oil)  |      |                                    |                      |      |      |    |
| Wall fixing screws   | No. 2 M4 screws   |      |                                    | No. 2 M5 screws      |      |      |    |

C1.48

OVERALL DIMENSIONS

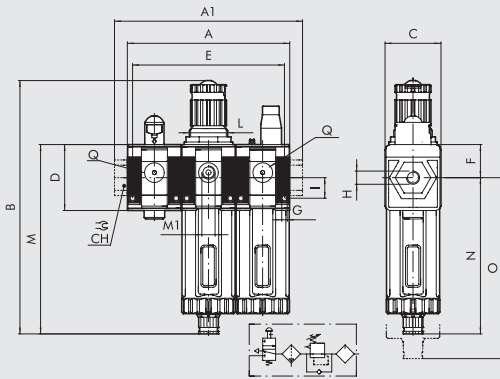

|                                    | SIZE 1 |                    |      | SIZE 2             |      |       |     |
|------------------------------------|--------|--------------------|------|--------------------|------|-------|-----|
|                                    | 1/8"   | 1/4"               | 3/8" | 3/8"               | 1/2" | 3/4"  | 1"  |
| H (threaded port)                  | 1/8"   | 1/4"               | 3/8" | 3/8"               | 1/2" | 3/4"  | 1"  |
| A                                  | 126    |                    |      |                    |      | 181.5 |     |
| A1                                 | -      | -                  | 128  | -                  | -    | 217   | 217 |
| B                                  |        |                    |      |                    |      |       |     |
|                                    | RMSA   | 198                |      |                    |      | 246   |     |
|                                    | RA/SAC | 202                |      |                    |      | 250   |     |
| C                                  |        | 44                 |      |                    |      | 61    |     |
| CH                                 |        |                    |      | -                  | -    | 32    | 36  |
| D                                  |        | 51.5               |      |                    |      | 70.5  |     |
| E                                  |        | 117.1              |      |                    |      | 168.5 |     |
| F                                  |        | 25.8               |      |                    |      | 38.2  |     |
| G                                  |        | Hole for M4 screws |      | Hole for M5 screws |      |       |     |
| I                                  |        | 16                 |      |                    |      | 22.5  |     |
| L                                  |        | M30x1.5            |      | M38x2              |      |       |     |
| M                                  |        |                    |      |                    |      |       |     |
|                                    | RMSA   | 148                |      |                    |      | 178   |     |
|                                    | RA/SAC | 152                |      |                    |      | 182   |     |
| M1 (pressure gauge port)           |        | 1/8"               |      |                    |      | 1/4"  |     |
| N                                  |        |                    |      |                    |      |       |     |
|                                    | RMSA   | 122.2              |      |                    |      | 139.8 |     |
|                                    | RA/SAC | 126.2              |      |                    |      | 143.8 |     |
| O                                  |        |                    |      |                    |      |       |     |
|                                    | RMSA   | 202                |      |                    |      | 245   |     |
|                                    | RA/SAC | 206                |      |                    |      | 249   |     |
| Q (no. 2 additional air takes-off) |        | 1/8"               |      |                    |      | 1/4"  |     |

KEY TO CODES

| 56                                      | 1                    | 1  | V       | 10  | B                  | 24  | L            | 10                             | 1  |
|---|----------------------|--|---------|---|--------------------|---|--------------|--------------------------------|--|
| SYNTESI                                 | SIZE                 | THREADED INPUT CONNECTION  | ELEMENT | TYPE  | ELEMENT            | DEGREE OF FILTRATION, TYPE OF CONDENSATE DRAIN AND SETTING RANGE  | ELEMENT      | OIL FILLING                    | THREADED OUTPUT CONNECTION   |
| 56 Syntesi<br>5X Syntesi anti-corrosion | 1 Size 1<br>2 Size 2 | 1 1/8" port<br>2 1/4" port<br>3 3/8" port<br>4 1/2" port<br>5 3/4" port<br>6 1" port | V V3V   | 10 Manual with Ø3.5 hole for padlocks<br>11 Manual with Ø7 hole for padlock | B Filter-regulator | <ul style="list-style-type: none"> <li>● 10 5 µm, RMSA, 0 to 2 bar</li> <li>● 20 20 µm, RMSA, 0 to 2 bar</li> <li>● 30 50 µm, RMSA, 0 to 2 bar</li> <li>● 40 5 µm, RA, 0 to 2 bar</li> <li>● 50 20 µm, RA, 0 to 2 bar</li> <li>● 60 50 µm, RA, 0 to 2 bar</li> <li>● 11 5 µm, SAC, 0 to 2 bar</li> <li>● 21 20 µm, SAC, 0 to 2 bar</li> <li>● 31 50 µm, SAC, 0 to 2 bar</li> <li>● 12 5 µm, RMSA, 0 to 4 bar</li> <li>● 22 20 µm, RMSA, 0 to 4 bar</li> <li>● 32 50 µm, RMSA, 0 to 4 bar</li> <li>● 42 5 µm, RA, 0 to 4 bar</li> <li>● 52 20 µm, RA, 0 to 4 bar</li> <li>● 62 50 µm, RA, 0 to 4 bar</li> <li>● 13 5 µm, SAC, 0 to 4 bar</li> <li>● 23 20 µm, SAC, 0 to 4 bar</li> <li>● 33 50 µm, SAC, 0 to 4 bar</li> <li>14 5 µm, RMSA, 0 to 8 bar</li> <li>24 20 µm, RMSA, 0 to 8 bar</li> <li>34 50 µm, RMSA, 0 to 8 bar</li> <li>44 5 µm, RA, 0 to 8 bar</li> <li>54 20 µm, RA, 0 to 8 bar</li> <li>64 50 µm, RA, 0 to 8 bar</li> <li>15 5 µm, SAC, 0 to 8 bar</li> <li>25 20 µm, SAC, 0 to 8 bar</li> <li>35 50 µm, SAC, 0 to 8 bar</li> <li>16 5 µm, RMSA, 0 to 12 bar</li> <li>26 20 µm, RMSA, 0 to 12 bar</li> <li>36 50 µm, RMSA, 0 to 12 bar</li> <li>46 5 µm, RA, 0 to 12 bar</li> <li>56 20 µm, RA, 0 to 12 bar</li> <li>66 50 µm, RA, 0 to 12 bar</li> <li>17 5 µm, SAC, 0 to 12 bar</li> <li>27 20 µm, SAC, 0 to 12 bar</li> <li>37 50 µm, SAC, 0 to 12 bar</li> </ul> | L Lubricator | 10 Manual filling from the top | 1 1/8" port<br>2 1/4" port<br>3 3/8" port<br>4 1/2" port<br>5 3/4" port<br>6 1" port |

● Not available in the anti-corrosion version.  
 + Anti-corrosion version available only in size 1.  
 RMSA: drain with manual condensate discharge and automatic discharge at zero pressure.  
 RA: automatic drain with condensate discharge, independent of pressure and flow rate. Version conveys the draining by inserting the pipe having internal diameter 6 mm in the lower port.  
 SAC: automatic drain with condensate discharge. Operates by pressure drop – requires variable air take-offs.

UNITS

V3V + FR + LUB Syntesi®



## GENERAL TECHNICAL DATA Syntesi®

Syntesi® is an important milestone achieved by Metal Work, the result of thirty years' experience producing air-treatment units. It has been studied in minute detail to obtain the best possible performance in a reduced space and with limited weight. The capacity is much higher than that of other units of the same size.

This modular unit features a very simple yet effective system that requires no brackets, stay bolts or yoke for assembling the elements.

The basic version of Syntesi® incorporates numerous functions that are not provided or are only optional with traditional units. Examples are padlockable knobs, additional pneumatic ports on the front and back, flow options from left to right or vice versa, regulators with compensation system - which are accurate even when the upstream pressure changes, with rapid downstream pressure relief - full indelible marking, automatic condensate drain even in size 1, and 360° visual inspection of oil and condensate levels. The basic materials, technopolymer and nickel-plated brass have excellent corrosion resistance. An anti-corrosion version is available with stainless steel components (screws, plates) or Geomet®-treated ones (regulator springs).



UNITS

GENERAL TECHNICAL DATA Syntesi®

| TECHNICAL DATA   | SIZE 1   |      |      | SIZE 2                               |      |      |    |
|--|--|------|------|--------------------------------------|------|------|----|
|  | 1/8"   | 1/4" | 3/8" | 3/8"                                 | 1/2" | 3/4" | 1" |
| Threaded port  |  |      |      |                                      |      |      |    |
| Max. input pressure  | bar  | 15   |      |                                      | 13   |      |    |
|  | MPa  | 1.5  |      |                                      | 1.3  |      |    |
|  | psi  | 217  |      |                                      | 188  |      |    |
| Flow rate  | See catalogue of the various elements  |      |      |                                      |      |      |    |
| Min/max temperature at 10 bar; 1 MPa; 145 psi  | °C from -10 to +50   |      |      | °C from -10 to +50                   |      |      |    |
| Padlockable knob   | The knobs of the regulators, filter regulators and standard sectioning valves can all be padlocked   |      |      |                                      |      |      |    |
| Fluid  | Compressed air or other inert gases  |      |      |                                      |      |      |    |
| Mounting position  | See catalogue of the various elements  |      |      |                                      |      |      |    |
| Direction of flow  | Flow options right to left or vice versa   |      |      |                                      |      |      |    |
| Additional air take-off, for pressure gauges or fittings                             | 1/8", front and rear, on all modules   |      |      | 1/4", front and rear, on all modules |      |      |    |
| Wall fixing screws   | No. 2 M4 screws  |      |      | No. 2 M5 screws                      |      |      |    |
| Certification for potentially explosive atmosphere according to ATEX 2014/34/EU rule |  II 3G Ex h IIC T5 Gc -10°C < Ta < 50°C<br>II 3D Ex h IIIC T100 °C Dc |      |      |                                      |      |      |    |

### ANTI-CORROSION VERSION

- Differences compared to the standard version:
- stainless steel screws
  - stainless steel plate for R, FR, V3V knobs
  - Geomet®-treated regulator spring and filter-regulator

**FIXING TO FRONT PORTS**



Do not use a spanner for fixing taper threaded elements to the front ports. Mount by hand and apply a liquid sealant (not teflon®).

**ROTARY BUSHINGS**



3/4" and 1" bushings in Size 2 rotate freely to facilitate assembly operations.

**LASER MARKING**



The following is marked indelibly on the body:

- Metal Work trademark
- Code
- Maximum pressure and temperature
- Degree of filtration or pressure range, where relevant
- Week and year of manufacture
- ATEX category
- Made in Italy

**MOUNTING OPTIONS**

**On the wall, using two screws**



**On a panel**

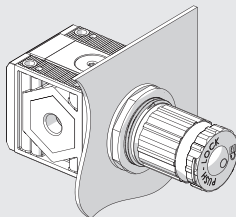

**Using knob bracket**

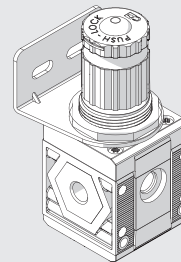

**Using a bracket**

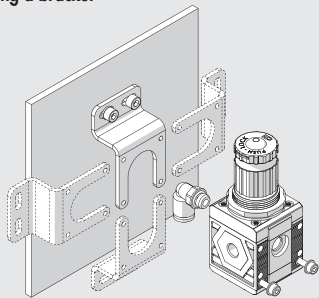

The bracket can be secured in any position, and the fittings can be mounted on the pressure gauge air intake at the back of the unit.

**On a DIN EN50022 bar with the opposite adaptor**

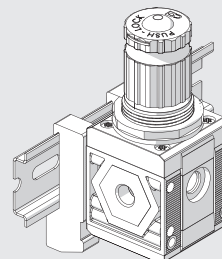

UNITS

GENERAL TECHNICAL DATA Synthesi®

MODULARITY AND FLEXIBILITY

UNITS

GENERAL TECHNICAL DATA Syntesi®





The various elements of Syntesi® A can be connected to the air feed and delivery circuit using pneumatic nickel brass or passivated aluminium ports® and can be fixed together using nipples®.

The nipples and ports are easy to remove by unscrewing the two front screws®. This solution has numerous advantages:

- Reduced overall dimensions.
- Free composition of multiple elements, without the need for brackets, stay bolts or yoke.
- The threads for the fittings are metallic, allowing high tightening torques, also for tapered threads.
- Maximum flexibility: a unit can be transformed at any time by adding an element or replacing a port with another one, e.g. 1/4" instead of 1/8".
- The air intake port can be the same or different from the outlet port, as desired.

Standard Syntesi® ports are: 1/8", 1/4", 3/8" for size 1; 3/8", 1/2", 3/4", 1" for size 2.

It may be necessary to use a vice to insert the bushes into size 2.

The nipples have different functions:

- Nipple® joins two elements of the same size together.
- Size adaptor® can be used to connect an element in the Syntesi® 2 series with one in the Syntesi® 1 series.
- The 90° adaptor® can be used to connect two 90° angled elements. For example, it can help directing the regulator knob or the control knob of a sectioning valve towards the user.
- The two-way air intake® is a simple and cost-effective system which, besides connecting two elements together, has 2 opposing threaded air intakes.
- The adaptor for Regtronic® can be used to fix the Regtronic 1/4" proportional valve to a Syntesi® size 1 element.

**Additional ports®.** On the front and back of ALL Syntesi® elements there is a port (1/8" for size 1, 1/4" for size 2) that can be used for pressure gauges®, pressure switches® or, given the high flow rate, as additional air take-off®. These ports are downstream of the element, so, for example, a regulator port can supply air at a set pressure or a filter port can supply filtered air (not valid for activated carbon filter and depurator).

**Wall fixing.** Only two through screws® are needed. No bulky brackets or additional flanges are required. The bracket® can be used to separate the unit from the fixing wall, e.g. to mount a fitting to the rear port.

**Fixing on a DIN EN50022 bar.** Can be done using the bracket kit®.

**Regulator fixing bracket®.** Regulators and filter-regulators can also be fixed using a steel bracket® that embraces the bell.

**Padlockable knob®.** The knobs of regulators, filter-regulator and sectioning valves can all be padlocked. The steel plate is included in the supply. You can insert up to two 3 mm diameter padlocks® on size 1 and three padlocks on size 2. As an alternative, the sectioning valve can have a steel plate suitable for a single 6 mm diameter padlock.

**Safety valve®.** The unit can incorporate a series 70 SAFE AIR® safety valve.

**Flowmeter series FLUX 1-2®.** The unit can incorporate a series FLUX 1 or FLUX 2 flow meter.

C1

# SYNTESI® KEY TO CODES

## KEY TO CODES SINGLE ELEMENT

| 56   | 1                        | 1   | F   | 10                             | 1   |
|--|--------------------------|---|---|--------------------------------|---|
| SYNTESI                                    | SIZE                     | THREADED INPUT CONNECTION   | ELEMENT   | TYPE                           | THREADED OUTPUT CONNECTION  |
| 56 Syntesi<br>5X Syntesi<br>anti-corrosion | 1 Size 1<br><br>2 Size 2 | 0 Without bushing<br>1 1/8" port<br>2 1/4" port<br>3 3/8" port<br><br>0 Without bushing<br>3 3/8" port<br>4 1/2" port<br>5 3/4" port<br>6 1" port | F Filter<br>D Depurator<br>C Active carbon filter<br>R Pressure regulator<br>B Filter-regulator<br>L Lubricator<br>● V Shut off valve<br>▲ A Progressive starter<br>▲ S Pressure switches<br>P Air take-off | Varies from element to element | 0 Without bushing<br>1 1/8" port<br>2 1/4" port<br>3 3/8" port<br><br>0 Without bushing<br>3 3/8" port<br>4 1/2" port<br>5 3/4" port<br>6 1" port |

- The anti-corrosion version of this element is only available with manual actuation.
- ▲ Not available in the anti-corrosion version.

## KEY TO CODES UNIT COMPOSED OF TWO OR THREE ELEMENTS

| 56   | 1                        | 1   | V   | 10                             | B   | 24                             | L   | 10                             | 1   |
|--|--------------------------|---|---|--------------------------------|---|--------------------------------|---|--------------------------------|---|
| SYNTESI                                    | SIZE                     | THREADED INPUT CONNECTION   | ELEMENT 1   | TYPE                           | ELEMENT 2   | TYPE                           | ELEMENT 3   | TYPE                           | THREADED OUTPUT CONNECTION  |
| 56 Syntesi<br>5X Syntesi<br>anti-corrosion | 1 Size 1<br><br>2 Size 2 | 1 1/8" port<br>2 1/4" port<br>3 3/8" port<br>3 3/8" port<br>4 1/2" port<br>5 3/4" port<br>6 1" port | F Filter<br>D Depurator<br>C Active carbon filter<br>R Pressure regulator<br>B Filter-regulator<br>L Lubricator<br>● V Shut off valve<br>▲ A Progressive starter<br>▲ S Pressure switches<br>P Air Take-off | Varies from element to element | F Filter<br>D Depurator<br>C Active carbon filter<br>R Pressure regulator<br>B Filter-regulator<br>L Lubricator<br>● V Shut off valve<br>▲ A Progressive starter<br>▲ S Pressure switches<br>P Air Take-off | Varies from element to element | F Filter<br>D Depurator<br>C Active carbon filter<br>R Pressure regulator<br>B Filter-regulator<br>L Lubricator<br>● V Shut off valve<br>▲ A Progressive starter<br>▲ S Pressure switches<br>P Air Take-off | Varies from element to element | 1 1/8" port<br>2 1/4" port<br>3 3/8" port<br>3 3/8" port<br>4 1/2" port<br>5 3/4" port<br>6 1" port |

- The anti-corrosion version of this element is only available with manual actuation.
- ▲ Not available in the anti-corrosion version.

UNITS

Syntesi® KEY TO CODES

C1.8

## Accessories

|  | Art. No. | Type No. |
|--|----------|----------|
| Bowl, size 1, RMSA semi-automated                  | 145611   | 9210100  |
| Bowl, size 1, SAC fully automated                  | 145613   | 9210102  |
| Filter element, size 1, 20 µm                      | 145620   | 9210151  |
| Filter element, size 1, 50 µm                      | 145621   | 9210152  |
| Valve poppet for filter regulator, size 1, 20 µm   | 145652   | 9210212  |
| Valve poppet for filter regulator, size 1, 50 µm   | 145653   | 9210213  |
| Mounting bracket, size 1, standard and anti-corr.  | 145658   | 9200716X |
| Adapter for DIN rail, size 1 and size 2            | 145660   | 9200718X |
| Pressure gauge, G1/8 rear centric, 0-12 bar, Ø40mm | 145470   | 9700101  |
| Pressure gauge, G1/8 rear centric, 0-12 bar, Ø50mm | 145472   | 9800101  |
| Pressure gauge, G1/8 rear cent., 0-12 bar, 40x40mm | 145476   | 9700110  |
| Connecting nipple kit, size 1                      | 144695   | 9210000  |
| Connecting element 90°, size 1                     | 145502   | 9210009  |
| Size adapter, size 1 - size 2, incl. 4 screws      | 145504   | 9210006  |
| Assembly key for bowl size 1, »bit«                | 145505   | 9170601  |
| Fastening screw, size 1                            | 145507   | 9210030  |
| Padlock  | 145509   | 9062401  |

## Spareparts

|  | Art. No. | Type No. |
|--|----------|----------|
| Automatic bleeder valve, RA                        | 145609   | 9000802  |
| Bowl, size 1, RA fully automated                   | 145612   | 9210101  |
| Bowl for lubricator, size 1, PA12                  | 145617   | 9210110  |
| Filter element, size 1, 5 µm                       | 145619   | 9210150  |
| Lubricator dome (drip cap), s1, w. oil filling cap | 145629   | 9210180  |
| Oil filling cap, size 1                            | 145631   | 9210181  |
| Spring, size 1, 0 - 12 bar                         | 145636   | 9210193  |
| Regulator cap (bell), size 1, 0 - 12 bar           | 145644   | 9210203  |
| Valve poppet for filter regulator, size 1, 5 µm    | 145651   | 9210211  |
| Threaded port bushing, size 1, G 1/8               | 144688   | 9210001  |