

Pressure gauge

Art. No. 145474

Type No. 9900101



Exemplary illustration

Technical data

Description	Pressure gauge, G1/4 rear centric, 0-12 bar, Ø63mm
-------------	--

Commercial data

Customs tariff number	90262040
Country of origin	IT
eCl@ss 5.1.4	27200601
eCl@ss 9.0	27200601
UNSPSC_Code_v190501	41103311
UNSPSC_CodeDesc_v190501	Manometers

SYNTESI® ACCESSORIES



MOUNTING BRACKET FOR REG. AND FR KNOB

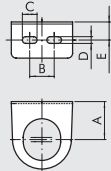

Code	Description
9200701	SF100 - BIT-ND 1/4 - SY1
9400701	SF200 - ND-3/8 1/2 - SY2

Code	A	B	C	D	E
9200701	32	20	12	5.5	14.2
9400701	42	40	12	5.5	15

MOUNTING BRACKET

Vertical mounting

Horizontal mounting

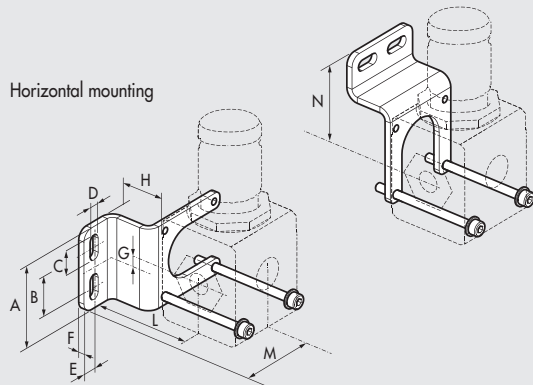

Code	Description
9200716X	Mounting bracket SY1
9200717X	Mounting bracket SY2

Note: Supplie complete with screws and washers.
Max torque 0.8 Nm for SY1 - Max torque 2.0 Nm for SY2
Codes to be used for units in the standard and the anti-corrosion version

Code	A	B	C	D	E	F	G	H	L	M	N
9200716X	41.5	20	12.7	5.5	7	3	0.8	25	43.8	46.5	47
9200717X	60	40	12.7	5.5	8	3	1.3	30	57.5	58.3	59.5

CONNECTION BRACKETS ON THE BAR (DIN EN50022)



Code	Description
9200718X	Connection brackets on DIN bar, SY1 - SY2

Note: 2 pieces per pack complete with screws and washers.
Max torque 0.8 Nm for SY1 - Max torque 2.0 Nm for SY2
Codes to be used for units in the standard and the anti-corrosion version

PRESSURE GAUGES

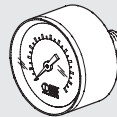

Code	Description
9700101	M 40 1/8 012
9700102	M 40 1/8 04
9800101	M 50 1/8 012
9800102	M 50 1/8 04
9900101	M 63 1/4 012



9700109	M 40x40 1/8 04
9700110	M 40x40 1/8 012

ADAPTERS FOR PRESSURE GAUGES (SY2)

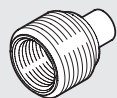

Code	Description
9210005	1/4 adapter for 1/8 pressure gauge

COIL 22 mm FOR APR AND V3V ELPN

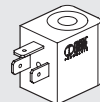

Code	Description
W0215000151	Coil 22 Ø 8 BA 2W-12VDC
W0215000101	Coil 22 Ø 8 BA 2W-24VDC
W0215000111	Coil 22 Ø 8 BA 3.5VA-24VAC
W0215000121	Coil 22 Ø 8 BA 3.5VA-110VAC
W0215000131	Coil 22 Ø 8 BA 3.5VA-220VAC

Electrical connection DIN 43650 B-IND

"UL" AND "CSA" COILS 22 mm



Code	Description
W0215000251	Coil 22 Ø 8 BA 2W-12VDC UR
W0215000201	Coil 22 Ø 8 BA 2W-24VDC UR
W0215000211	Coil 22 Ø 8 BA 3.5VA-24VAC UR
W0215000221	Coil 22 Ø 8 BA 3.5VA-110VAC UR
W0215000231	Coil 22 Ø 8 BA 3.5VA-220VAC UR

Electrical connection DIN 43650 B-IND

COIL 30 mm FOR APR AND V3V ELPN

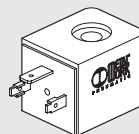

Code	Description
W0210010100	Coil 30 Ø 8 2W-24VDC
W0210011100	Coil 30 Ø 8 3.5VA-24VAC 50/60 HZ
W0210012100	Coil 30 Ø 8 3.5VA-110VAC 50/60 HZ
W0210013100	Coil 30 Ø 8 3.5VA-220VAC 50/60 HZ

Electrical connection DIN 43650 - A

UNITS

SYNTESI® ACCESSORIES

KIT FOR COIL EEXM

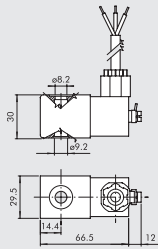

Code	Description
0227606913	Kit for coil 30 24 VDC EEXMT5 cable 3m
0227606915	Kit for coil 30 24 VDC EEXMT5 cable 5m
0227608013	Kit for coil 30 24 VAC EEXMT5 cable 3m
0227608015	Kit for coil 30 24 VAC EEXMT5 cable 5m
0227608023	Kit for coil 30 110 VAC EEXMT5 cable 3m
0227608025	Kit for coil 30 110 VAC EEXMT5 cable 5m
0227608033	Kit for coil 30 230 VAC EEXMT5 cable 3m
0227608035	Kit for coil 30 230 VAC EEXMT5 cable 5m

According to ATEX 2014/34/EU rule,
 Ex II 2G Ex mb IIC T4/T5 Gb
 Ex II 2D Ex tb IIIC T130/T95 °C IP66 Db
 N.B.: Supplied complete with adapter for Ø8 mm sleeve

ELECTRIC CONNECTOR 22 mm FOR COILS DIN 43650 B-IND

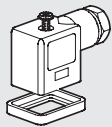

Code	Description
W0970510011	Connector standard
W0970510012	Connector 22 LED 24V
W0970510013	Connector 22 LED 110V
W0970510014	Connector 22 LED 220V
W0970510015	Connector 22 LED VDR 24V
W0970510016	Connector 22 LED VDR 110V
W0970510017	Connector 22 LED VDR 220V
W0970510070	Connector 22 II 2 GD ATEX

ELECTRIC CONNECTOR 30 mm FOR COILS DIN 43650-A

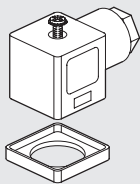

Code	Description
W0970520033	Connector 30 STD
W0970520034	Connector 30 LED 24V
W0970520035	Connector 30 LED 110V
W0970520036	Connector 30 LED 220V
W0970520037	Connector 30 LED VDR 24V
W0970520038	Connector 30 LED VDR 110V
W0970520039	Connector 30 LED VDR 220V

M8 STRAIGHT CONNECTOR WITH CABLE FOR PRESSURE SWITCHES

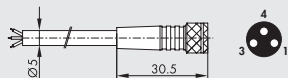

Pin	Cable color
1	Brown
3	Blue
4	Black

Code	Description
02400A0100	M8 female 3 PIN HIGH FLEX CL6 connector with cable L = 1 m
02400A0250	M8 female 3 PIN HIGH FLEX CL6 connector with cable L = 2.5 m
02400A0500	M8 female 3 PIN HIGH FLEX CL6 connector with cable L = 5 m
02400A1000	M8 female 3 PIN HIGH FLEX CL6 connector with cable L = 10 m

Mobile laying cable, class 6 according to IEC 60228

KIT COIL SIDE 22 IP65



Code	Description
0222100100	Kit for coils 22 - IP65

Improved IP65 protection, even after prolonged exposure to atmospheric agents.

THREADED PORT

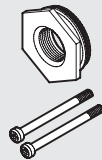

Code	Description
9210001	Kit IN OUT 1/8 SY1
9210002	Kit IN OUT 1/4 SY1
9210003	Kit IN OUT 3/8 SY1
9210011	Kit IN OUT 3/8 SY2
9210012	Kit IN OUT 1/2 SY2
9210013	Kit IN OUT 3/4 SY2
9210014	Kit IN OUT 1 SY2
9210001X	Kit IN OUT 1/8 SY1 anti-corrosion
9210002X	Kit IN OUT 1/4 SY1 anti-corrosion
9210003X	Kit IN OUT 3/8 SY1 anti-corrosion
9210011X	Kit IN OUT 3/8 SY2 anti-corrosion
9210012X	Kit IN OUT 1/2 SY2 anti-corrosion
9210013X	Kit IN OUT 3/4 SY2 anti-corrosion
9210014X	Kit IN OUT 1 SY2 anti-corrosion

Max torque 0.4 Nm for SY1
 Max torque 2.5 Nm for SY2

CONNECTING NIPPLE KIT

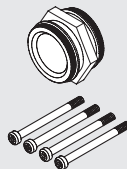

Code	Description
9210000	Connecting nipple kit SY1
9210010	Connecting nipple kit SY2
9210000X	Connecting nipple kit SY1 anti-corrosion
9210010X	Connecting nipple kit SY2 anti-corrosion

Max torque 0.4 Nm for SY1
 Max torque 2.5 Nm for SY2

90° CONNECTING ELEMENT KIT

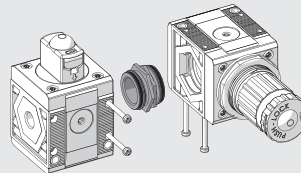

Code	Description
9210009	90° SY1 connection element kit
9210019	90° SY2 connection element kit
9210009X	90° anti-corrosion SY1 connection element kit
9210019X	90° anti-corrosion SY2 connection element kit

Max torque 0.4 Nm for SY1
 Max torque 2.5 Nm for SY2

**KIT CONNECTING REGTRONIC 1/4 (PAGE C6.10)
AND GS REGULATOR (PAGE C6.2)**

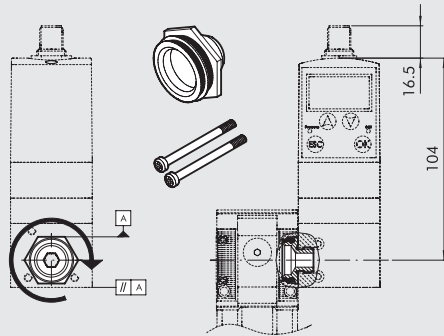

Code	Description
9210004	Adapter for regtronic 1/4 SY1

Max torque for screw, 0.4 Nm

Instructions:

- 1) Screw the connecting bushing onto the REGTRONIC 1/4 as far as it will go.
Use sealant on the G1/4 thread to provide a further seal.
- 2) Unscrew the bushing slightly until two surfaces of the hexagon are parallel to the body of REGTRONIC 1/4 (see diagram).
- 3) Insert the bushing into the Syntesis® unit.
- 4) Tighten the two self-tapping screws in the Syntesis® unit to a torque of 0.4 Nm max.

SY1 - SY2 SIZE ADAPTER

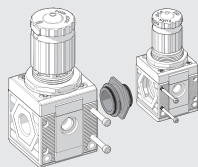

Code	Description
9210006	SY1 - SY2 size adapter
9210006X	SY1 - SY2 size adapter anti-corrosion

Max torque for screw, 0.4 Nm for SY1
Max torque for screw, 2.5 Nm for SY2

SY1 - SY2 KIT FOR CONNECTION TO FLUX 1 - 2



Code	Description
900099A002	Adapter FLUX 1 - SY1
900099A003	Adapter FLUX 2 - SY2

Max torque for screw, 0.4 Nm for SY1
Max torque for screw, 2.5 Nm for SY2
See page C6.33 for the assembly diagram.

SY1 - SY2 KIT FOR CONNECTION TO SERIE 70 SAFE AIR® VALVES

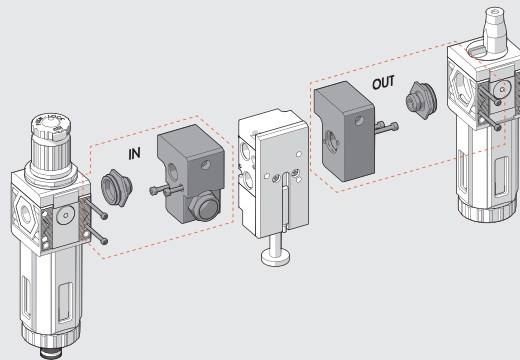

Code	Description
9210015	IN 1/4 SY1 block accessory
9210016	OUT 1/4 SY1 block accessory
9210022	IN 3/8 SY1 block accessory
9210023	OUT 3/8 SY1 block accessory
9210017	IN 3/8 SY2 block accessory
9210018	OUT 3/8 SY2 block accessory
9210020	IN 1/2 SY2 block accessory
9210021	OUT 1/2 SY2 block accessory

Max torque for screw, 0.4 Nm for SY1
Max torque for screw, 2.5 Nm for SY2

See page B1.151 for the assembly diagram.

BOWL DISASSEMBLY SPANNER

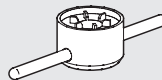

Code	Description
9170601	CS TF - TL BIT/SY1
9210050	CS TF - TL SY2

WALL-FIXING SCREW



Code	Description
9210030	M4 x 55 fixing screw SY1
9210031	M5 x 75 fixing screw SY2

Max torque 0.8 Nm for SY1
Max torque 2.0 Nm for SY2

PADLOCK



Code	Description
9062401	Padlock

UNITS

Syntesis® ACCESSORIES

SYNTESI® SPARE PARTS

UNITS

Syntesi® SPARE PARTS

AUTOMATIC DRAIN (RA)

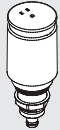

Code	Description
9000802	RA automatic drain spare part

AUTOMATIC DRAIN (SAC)



Code	Description
9000803	Spares SAC automatic drain

BOWL RMSA/RA/SAC

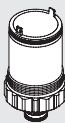

Code	Description
9210100	Bowl FIL FR DEP RMSA SY1
9210101	Bowl FIL FR RA SY1
9210102	Bowl FIL FR DEP SAC SY1
9210105	Bowl FIL FR DEP RMSA SY2
9210106	Bowl FIL FR RA SY2
9210107	Bowl FIL FR DEP SAC SY2

LUBRICATOR BOWL

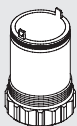

Code	Description
9210110	Bowl LUB SY1
9210115	Bowl LUB SY2

FILTERING ELEMENT

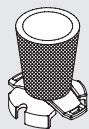

Code	Description
9210150	Filtering element 5µm (yellow) SY1
9210151	Filtering element 20µm (white) SY1
9210152	Filtering element 50µm (blue) SY1
9210155	Filtering element 5µm (yellow) SY2
9210156	Filtering element 20µm (white) SY2
9210157	Filtering element 50µm (blue) SY2

PURIFIER FILTERING ELEMENT



Code	Description
9210160	Cartridge 0.01µm DEP SY1
9210165	Cartridge 0.01µm DEP SY2
9210162	Cartridge 1µm DEP SY1
9210167	Cartridge 1µm DEP SY2

AC FILTERING ELEMENT (ACTIVE CARBON)



Code	Description
9210161	Cartridge AC SY1
9210166	Cartridge AC SY2

TRANSPARENT LUBRICATOR COVER

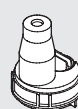

Code	Description
9210180	Transparent cover LUB SY1
9210185	Transparent cover LUB SY2

LUBRICATOR OIL-FILLING CAP



Code	Description
9210181	Oil-filling cap LUB SY1
9210186	Oil-filling cap LUB SY2

SPRINGS FOR REGULATORS AND FR



Code	Description
9210190	Spares MO 02 SY1
9210191	Spares MO 04 SY1/SY1 anti-corrosion
9210192	Spares MO 08 SY1
9210193	Spares MO 012 SY1
9210195	Spares MO 02 SY2
9210196	Spares MO 04 SY2
9210197	Spares MO 08 SY2
9210198	Spares MO 012 SY2
9210192X	Spares 08 SY1 anti-corrosion
9210193X	Spares 012 SY1 anti-corrosion
9210197X	Spares 08 SY2 anti-corrosion
9210198X	Spares 012 SY2 anti-corrosion

BELL FOR REG AND FR

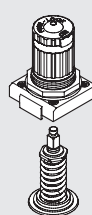

Code	Description
9210200	Bell 02 SY1
9210201	Bell 04 SY1
9210202	Bell 08 SY1
9210203	Bell 012 SY1
9210220	Bell 02 SY2
9210221	Bell 04 SY2
9210222	Bell 08 SY2
9210223	Bell 012 SY2
9210202X	Bell 08 SY1 anti-corrosion
9210203X	Bell 012 SY1 anti-corrosion
9210222X	Bell 08 SY2 anti-corrosion
9210223X	Bell 012 SY2 anti-corrosion

POPPET FOR REG



Code	Description
9210210	Poppet REG SY1
9210230	Poppet REG SY2
9210210X	Poppet REG SY1 anti-corrosion
9210230X	Poppet REG SY2 anti-corrosion

NOTES

POPPET FOR FR

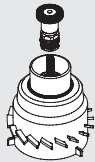

Code	Description
9210211	Poppet FR 5µm SY1
9210212	Poppet FR 20µm SY1
9210213	Poppet FR 50µm SY1
9210231	Poppet FR 5µm SY2
9210232	Poppet FR 20µm SY2
9210233	Poppet FR 50µm SY2

CNOMO CONTROL FOR V3V AND APR SY2

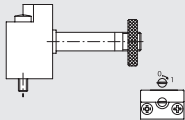

Code	Description
9453922	Elpn Cnomo control kit, manual bistable

NOTES

UNITS

Synthesis SPARE PARTS