

# 5/3-way valve

electropneumatic

**PLUS** ||

Art. No. 145725

Type No. 7030022300

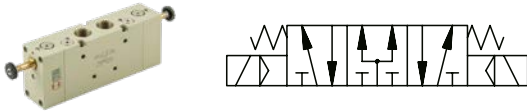

Exemplary illustration

Traditional way valves of series 70 in electropneumatic version. These valves have a wide range of applications as bushing valves, direct mounting on the cylinder with special adapters or as series valves with multi-base plates and individual interlinking plates (supply strips).

## Technical data

Operating pressure	2.5 - 10 bar
Medium temperature	-10 to 60 °C
Ambient temperature	-10 to 60 °C
Medium	Filtered compressed air with or without lubrication. If lubricated, then continuous.
Sealant	NBR
Flow rate measurement 1	Flow rate at 6 bar and $\Delta p$ 0.5 bar
Flow rate 1	3200 NI/min
Flow rate measurement 2	Flow rate at 6 bar and $\Delta p$ 1.0 bar
Flow rate 2	4600 NI/min
Connection	G 1/2
DN	15
Operation	mid-position pressurised
Function	5/3
Manual control	latching
Series	Valves series 70
Scope of delivery	without connector and coil
TechnischerHinweis1	Plug and coil are not included in delivery!

## Commercial data

Customs tariff number	84818079
Country of origin	IT
eCl@ss 5.1.4	27291501
eCl@ss 9.0	27291390
UNSPSC_Code_v190501	40141603
UNSPSC_CodeDesc_v190501	Pneumatic valves

## VALVES SERIES 70

The Series 70 forms part of Metal Work's full range of traditional valves.

They are available in sizes 1/8", 1/4", 3/8" and 1/2", versions 3/2, 5/2, 5/3 and double 3/2, with mechanical, manual, pneumatic and electric drives.

They can be installed in line, onto a wall, on the cylinder (using a special bracket) or in series (on a multiple or modular base) to suit all possible applications.

A range of valves (Series 70 LT) designed using components for specific low-temperature applications is now available for the most commonly used types and sizes.

These highly reliable valves comply with the main applicable standards, including Atex, ISO 13489 and SIL, as stated in the documents and certificates available online.



TECHNICAL DATA		1/8"	1/4"	3/8"	1/2"
Thread on the valve ports		1/8"	1/4"	3/8"	1/2"
Operating pressure series 70 versions	bar	2.5 to 10			
monostable and bistable differential		1 to 10			
bistable		vacuum to 10			
asserved					
Operating pressure series 70 LT (low temperature) versions	bar	vacuum to 10			
hand operated		vacuum to 10			-
pneumatic and solenoid/pneumatic		5 to 10			-
	t = -40°C to -10°C	3 to 10			-
	t = -10°C to +60°C				-
Minimum pilot pressure	bar	2.5			
Operating temperature range	°C	-10 to +60			
series 70 versions		-40 to +60			
series 70 LT (low temperature) versions					
Nominal diameter	mm	5	7.5	13.3	15
Conductance C	Nl/min · bar	121.43	264.26	505.52	971.43
Critical ratio b	bar/bar	0.32	0.27	0.32	0.43
Flow rate at 6 bar ΔP 0.5 bar	Nl/min	400	750	1560	3200
Flow rate at 6 bar ΔP 1 bar	Nl/min	550	1100	2150	4600
Installation		In any position (vertical assembly is not recommended for bistable valves subjected to vibration)			
Fluid		Filtered air without lubrication; lubrication, if used, must be continuous.			
Recommended lubricant		For series 70 LT (low-temperature) versions, it is recommended to use of perferamente dried air. ISO and UNI FD 22			
Maximum coil nut torque	Nm	For series 70 LT (low-temperature) it is not expected to be used with lubricated air.			
Compatibility with oils		1 See chapter Z1			

### COMPONENTS SERIES 70

- ① VALVE BODY: Aluminium
- ② CONTROL/END CAP: plastic
- ③ SPOOL: chemically nickel-plated aluminium
- ④ DISTANCE PLATES: plastic
- ⑤ GASKETS: NBR
- ⑥ PISTONS: Hostaform®
- ⑦ PISTON GASKET: NBR
- ⑧ FILTER: plastic
- ⑨ SPRINGS: special steel
- ⑩ OPERATOR: Brass pipe - Stainless steel core



**COMPONENTS SERIES 70 LT (LOW TEMPERATURE)**

- ① ALVE BODY: aluminium
- ② CONTROL/END CAP: aluminium
- ③ SPOOL: chemically nickel-plated aluminium
- ④ DISTANCE PLATES: plastic
- ⑤ GASKETS: HNBR
- ⑥ PISTONS: aluminium
- ⑦ PISTON GASKET: HNBR
- ⑧ FILTER: plastic
- ⑨ SPRINGS: special steel
- ⑩ OPERATOR: brass pipe - Stainless steel core  
(version specific for low-temperature applications)



VALVES

VALVES SERIES 70

**FLOW CHARTS**

**VALVES SERIES 70 1/8"**

Flow rates



**VALVES SERIES 70 1/4"**

Flow rates



**VALVES SERIES 70 3/8"**

Flow rates



**VALVES SERIES 70 1/2"**

Flow rates



**VALVES SERIES 70, SOLENOID/PNEUMATIC**

TECHNICAL DATA		1/8"	1/4"	3/8"	1/2"
Operating pressure:					
• monostable and bistable differential	bar	2.5 to 10			
• bistable	bar	1 to 10			
• asserved	bar	Vacuum to 10			
Minimum pilot pressure	bar	2.5			
Operating temperature range	°C	-10 to +60			
Nominal diameter	mm	5	7.5	13.3	15
Conductance C	NI/min · bar	121.43	264.26	505.52	971.43
Critical ratio b	bar/bar	0.32	0.27	0.32	0.43
Flow rate at 6 bar ΔP 0.5 bar	NI/min	400	750	1560	3200
Flow rate at 6 bar ΔP 1 bar	NI/min	550	1100	2150	4600
TRA / TRR monostable at 6 bar	ms	15/35	19/45	21/72	36/100
TRA / TRR bistable at 6 bar	ms	20/20	21/21	18/18	25/25
Coil voltage values		12; 24 VDC - 24; 110; 220V AC 50/60Hz			
Power		2 W (DC) 3.5VA (AC)			
Voltage tolerance	%	-10 to +15			
Insulation class		F 155			
Maximum coil nut torque	Nm	1			
Hand operator		Bistable			



VALVES

**SYNOPTIC, SIZES AND VERSIONS**

SO V	2	3	SO	S	NC
FAMILY	DIMENSIONS	FUNCTION	OPERATORS 14	RESETTING (12)	FURTHER DETAILS
SOV solenoid/ pneumatic	2 1/8"	3 3/2	SO solenoid	S mechanical springs	OO no indication
	3 1/4"	5 5/2	SE solenoid assisted	B bistable	NC normally closed
	C 3/8"	6 5/3		D differential	NO normally open
	4 1/2"	■ 8 2-3/2		P pneumatic	CC closed centres
				◆ A pneumatic/mechanical spring	OC open centres
					PC pressure centres
					▲ NC-NO normally closed - normally open

- Only available for size 1/8" and 1/4"
- ◆ On demand
- ▲ Only available for function 2-3/2

VALVES SERIES 70, PNEUMATIC

**VALVES SERIES 70, SOLENOID/PNEUMATIC, PILOT-ASSISTED SOLENOID/PNEUMATIC, 1/8"**

**MONOSTABLE 3/2 NO, 1/8"**



Symbol	Code	Abbrev.	Weight [g]
	7010020400	SOV 23 SOS NO	100

**MONOSTABLE 3/2 NC, 1/8"**



Symbol	Code	Abbrev.	Weight [g]
	7010020200	SOV 23 SOS NC	100
	7010020500	SOV 23 SES NC	100

MONOSTABLE 5/2, 1/8"

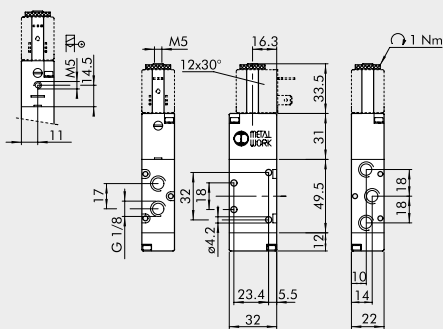

Symbol	Code	Abbrev.	Weight [g]
	7010021100	SOV 25 SOS OO	128
	7010021500	SOV 25 SES OO	129

BISTABLE 5/2, 1/8"



Symbol	Code	Abbrev.	Weight [g]
	7010021200	SOV 25 SOB OO	160
	7010021300	SOV 25 SOD OO	166
	7010021600	SOV 25 SEB OO	160

BISTABLE 3/2, 1/8"



Symbol	Code	Abbrev.	Weight [g]
	7010020100	SOV 23 SOB OO	135
	7010020300	SOV 23 SEB OO	136

DOUBLE 3/2, 1/8"



Symbol	Code	Abbrev.	Weight [g]
	7010023100	SOV 28 SOS NC	186
	7010023200	SOV 28 SOS NO	186
	7010023300	SOV 28 SOS NC-NO	186
	7010023400	SOV 28 SES NC	186
	7010023500	SOV 28 SES NO	186
	7010023600	SOV 28 SES NC-NO	186

**MONOSTABLE 5/3, 1/8"**



**NOTES**

Symbol	Code	Abbrev.	Weight [g]
	7010022100	SOV 26 SOS CC	190
	7010022200	SOV 26 SOS OC	190
	7010022300	SOV 26 SOS PC	190
	7010022400	SOV 26 SES CC	188
	7010022500	SOV 26 SES OC	188
	7010022600	SOV 26 SES PC	188

**VALVES SERIES 70, SOLENOID/PNEUMATIC, PILOT-ASSISTED SOLENOID/ PNEUMATIC, 1/4"**

**MONOSTABLE 3/2 NO, 1/4"**



**MONOSTABLE 3/2 NC, 1/4"**

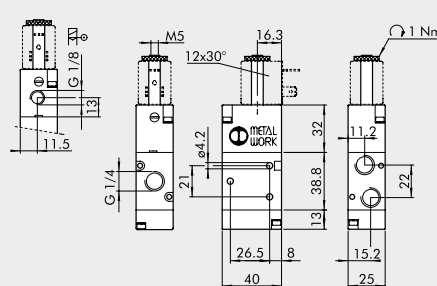

Symbol	Code	Abbrev.	Weight [g]
	7020020400	SOV 33 SOS NO	152

Symbol	Code	Abbrev.	Weight [g]
	7020020200	SOV 33 SOS NC	152
	7020020500	SOV 33 SES NC	152

VALVES

VALVES SERIES 70, SOLENOID/PNEUMATIC

## VALVES SERIES 70

VALVES

VALVES SERIES 70

The Series 70 forms part of Metal Work's full range of traditional valves.

They are available in sizes 1/8", 1/4", 3/8" and 1/2", versions 3/2, 5/2, 5/3 and double 3/2, with mechanical, manual, pneumatic and electric drives.

They can be installed in line, onto a wall, on the cylinder (using a special bracket) or in series (on a multiple or modular base) to suit all possible applications.

A range of valves (Series 70 LT) designed using components for specific low-temperature applications is now available for the most commonly used types and sizes.

These highly reliable valves comply with the main applicable standards, including Atex, ISO 13489 and SIL, as stated in the documents and certificates available online.



TECHNICAL DATA		1/8"	1/4"	3/8"	1/2"
Thread on the valve ports		1/8"	1/4"	3/8"	1/2"
Operating pressure series 70 versions	bar	2.5 to 10			
monostable and bistable differential		1 to 10			
bistable		vacuum to 10			
asserved					
Operating pressure series 70 LT (low temperature) versions	bar	vacuum to 10			
hand operated		-			
pneumatic and solenoid/pneumatic	t = -40°C to -10°C	5 to 10			
	t = -10°C to +60°C	3 to 10			
Minimum pilot pressure	bar	2.5			
Operating temperature range	°C	-10 to +60			
series 70 versions		-40 to +60			
series 70 LT (low temperature) versions					
Nominal diameter	mm	5	7.5	13.3	15
Conductance C	Nl/min · bar	121.43	264.26	505.52	971.43
Critical ratio b	bar/bar	0.32	0.27	0.32	0.43
Flow rate at 6 bar ΔP 0.5 bar	Nl/min	400	750	1560	3200
Flow rate at 6 bar ΔP 1 bar	Nl/min	550	1100	2150	4600
Installation		In any position (vertical assembly is not recommended for bistable valves subjected to vibration)			
Fluid		Filtered air without lubrication; lubrication, if used, must be continuous.			
Recommended lubricant		For series 70 LT (low-temperature) versions, it is recommended to use of perferamente dried air. ISO and UNI FD 22			
Maximum coil nut torque	Nm	For series 70 LT (low-temperature) it is not expected to be used with lubricated air. 1			
Compatibility with oils		See chapter Z1			

### COMPONENTS SERIES 70

- ① VALVE BODY: Aluminium
- ② CONTROL/END CAP: plastic
- ③ SPOOL: chemically nickel-plated aluminium
- ④ DISTANCE PLATES: plastic
- ⑤ GASKETS: NBR
- ⑥ PISTONS: Hostaform®
- ⑦ PISTON GASKET: NBR
- ⑧ FILTER: plastic
- ⑨ SPRINGS: special steel
- ⑩ OPERATOR: Brass pipe - Stainless steel core





**COMPONENTS SERIES 70 LT (LOW TEMPERATURE)**

- ① ALVE BODY: aluminium
- ② CONTROL/END CAP: aluminium
- ③ SPOOL: chemically nickel-plated aluminium
- ④ DISTANCE PLATES: plastic
- ⑤ GASKETS: HNBR
- ⑥ PISTONS: aluminium
- ⑦ PISTON GASKET: HNBR
- ⑧ FILTER: plastic
- ⑨ SPRINGS: special steel
- ⑩ OPERATOR: brass pipe - Stainless steel core  
(version specific for low-temperature applications)



VALVES

VALVES SERIES 70

**FLOW CHARTS**

**VALVES SERIES 70 1/8"**

Flow rates

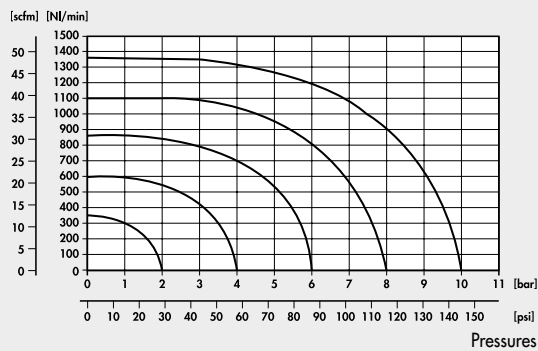

**VALVES SERIES 70 1/4"**

Flow rates



**VALVES SERIES 70 3/8"**

Flow rates

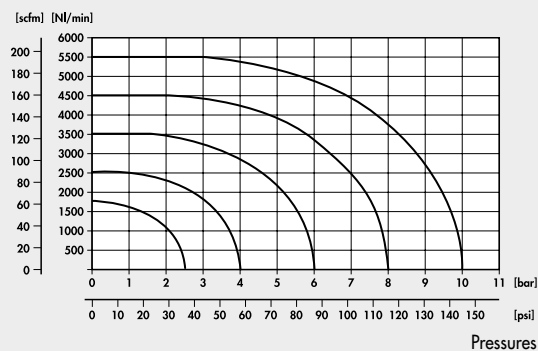

**VALVES SERIES 70 1/2"**

Flow rates





**VALVES SERIES 70, SOLENOID/PNEUMATIC**

TECHNICAL DATA	1/8"	1/4"	3/8"	1/2"	
Operating pressure:					
• monostable and bistable differential	bar 2.5 to 10				
• bistable	bar 1 to 10				
• asserved	bar Vacuum to 10				
Minimum pilot pressure	bar 2.5				
Operating temperature range	°C -10 to +60				
Nominal diameter	mm 5	7.5	13.3	15	
Conductance C	Nl/min · bar	121.43	264.26	505.52	971.43
Critical ratio b	bar/bar	0.32	0.27	0.32	0.43
Flow rate at 6 bar ΔP 0.5 bar	Nl/min	400	750	1560	3200
Flow rate at 6 bar ΔP 1 bar	Nl/min	550	1100	2150	4600
TRA / TRR monostable at 6 bar	ms	15/35	19/45	21/72	36/100
TRA / TRR bistable at 6 bar	ms	20/20	21/21	18/18	25/25
Coil voltage values	12; 24 VDC - 24; 110; 220V AC 50/60Hz				
Power	2 W (DC) 3.5VA (AC)				
Voltage tolerance	% -10 to +15				
Insulation class	F 155				
Maximum coil nut torque	Nm 1				
Hand operator	Bistable				

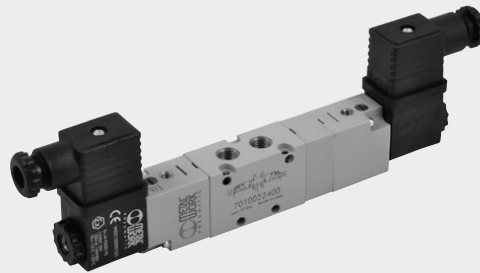

VALVES

**SYNOPTIC, SIZES AND VERSIONS**

SO V FAMILY	2 DIMENSIONS	3 FUNCTION	SO OPERATORS 14	S RESETTING (12)	NC FURTHER DETAILS
SOV solenoid/ pneumatic	2 1/8"	3 3/2	SO solenoid	S mechanical springs	OO no indication
	3 1/4"	5 5/2	SE solenoid assisted	B bistable	NC normally closed
	C 3/8"	6 5/3		D differential	NO normally open
	4 1/2"	■ 8 2-3/2		P pneumatic	CC closed centres
				◆ A pneumatic/mechanical spring	OC open centres
					PC pressure centres
					▲ NC-NO normally closed - normally open

- Only available for size 1/8" and 1/4"
- ◆ On demand
- ▲ Only available for function 2-3/2

VALVES SERIES 70, PNEUMATIC

**VALVES SERIES 70, SOLENOID/PNEUMATIC, PILOT-ASSISTED SOLENOID/PNEUMATIC, 1/8"**

**MONOSTABLE 3/2 NO, 1/8"**



Symbol	Code	Abbrev.	Weight [g]
	7010020400	SOV 23 SOS NO	100

**MONOSTABLE 3/2 NC, 1/8"**



Symbol	Code	Abbrev.	Weight [g]
	7010020200	SOV 23 SOS NC	100
	7010020500	SOV 23 SES NC	100

MONOSTABLE 5/2, 1/8"



Symbol	Code	Abbrev.	Weight [g]
	7010021100	SOV 25 SOS OO	128
	7010021500	SOV 25 SES OO	129

BISTABLE 5/2, 1/8"



Symbol	Code	Abbrev.	Weight [g]
	7010021200	SOV 25 SOB OO	160
	7010021300	SOV 25 SOD OO	166
	7010021600	SOV 25 SEB OO	160

BISTABLE 3/2, 1/8"



Symbol	Code	Abbrev.	Weight [g]
	7010020100	SOV 23 SOB OO	135
	7010020300	SOV 23 SEB OO	136

DOUBLE 3/2, 1/8"



Symbol	Code	Abbrev.	Weight [g]
	7010023100	SOV 28 SOS NC	186
	7010023200	SOV 28 SOS NO	186
	7010023300	SOV 28 SOS NC-NO	186
	7010023400	SOV 28 SES NC	186
	7010023500	SOV 28 SES NO	186
	7010023600	SOV 28 SES NC-NO	186

**MONOSTABLE 5/3, 1/8"**

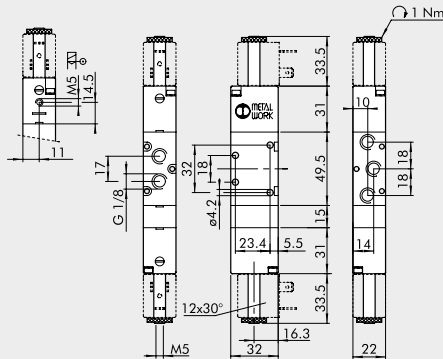

**NOTES**

Symbol	Code	Abbrev.	Weight [g]
	7010022100	SOV 26 SOS CC	190
	7010022200	SOV 26 SOS OC	190
	7010022300	SOV 26 SOS PC	190
	7010022400	SOV 26 SES CC	188
	7010022500	SOV 26 SES OC	188
	7010022600	SOV 26 SES PC	188

**VALVES SERIES 70, SOLENOID/PNEUMATIC, PILOT-ASSISTED SOLENOID/ PNEUMATIC, 1/4"**

**MONOSTABLE 3/2 NO, 1/4"**

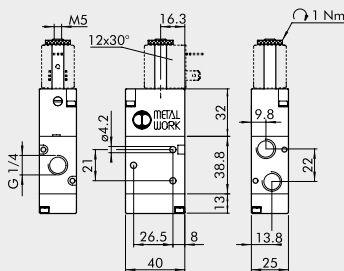

**MONOSTABLE 3/2 NC, 1/4"**

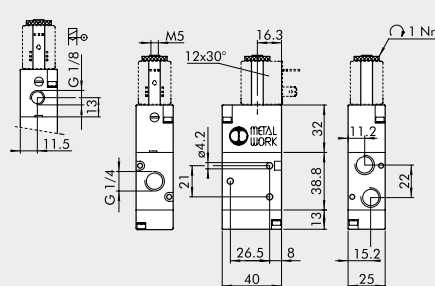

Symbol	Code	Abbrev.	Weight [g]
	7020020400	SOV 33 SOS NO	152

Symbol	Code	Abbrev.	Weight [g]
	7020020200	SOV 33 SOS NC	152
	7020020500	SOV 33 SES NC	152

VALVES

VALVES SERIES 70, SOLENOID/PNEUMATIC



**MONOSTABLE, SOLENOID/PNEUMATIC 5/2**

**BISTABLE, SOLENOID/PNEUMATIC 5/2**

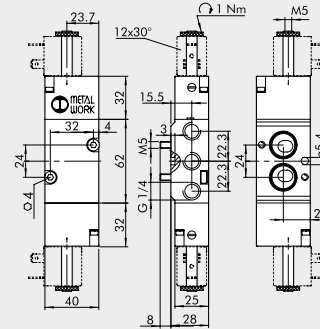
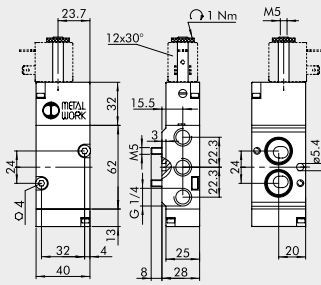

Symbol	Code	Abbrev.	Weight [g]
	7021020100	SOV A5 SOS OO	234

Symbol	Code	Abbrev.	Weight [g]
	7021020200	SOV A5 SOB OO	270

**ACCESSORIES FOR NAMUR VALVES SOV, SOLENOID/PNEUMATIC**

Refer to page B1.60 for coils and connectors



**NOTES**

VALVES

VALVES NAMUR

## Accessories

	Art. No.	Type No.
Solenoid 12 V DC, 2 W	118631	400-514-41
Solenoid 24 V DC, 2 W	118632	400-514-42
Solenoid 24 V AC, 50/60 Hz, 3,5 VA	118628	400-514-01
Solenoid 110 V AC, 50/60 Hz, 3,5 VA	118629	400-514-07
Solenoid 230 V AC, 50/60 Hz, 3,5 VA	118630	400-514-17
Solenoid 12 V DC, 5 W	118636	400-517-41
Solenoid 24 V DC, 5 W	118637	400-517-42
Solenoid 24 V AC, 50/60 Hz, 5 VA	118633	400-517-01
Solenoid 110 V AC, 50/60 Hz, 5 VA	118634	400-517-07
Solenoid 230 V AC, 50/60 Hz, 5 VA	118635	400-517-17
Plug connector, standard, industrial form B, black	117313	1920.9P
Plug connector with LED, 24 V, transparent	117316	1920.9PL.42
Plug connector with LED, 110 V, transparent	151011	1920.9PL110
Plug connector with LED, 230 V, transparent	117314	1920.9PL.17
Plug connector with LED, varistor 24 V, transparent	117318	1920.9PLV42
Plug connector with LED, varistor 110 V, transparent	129849	1920.9PLV110
Plug connector with LED, varistor 230 V, transparent	117317	1920.9PLV17
Plug connector, ATEX II 2 GD, black	123182	1920.9PL2GD-EX