

3/2-way valve »BASIC«

electropneumatic

EASY

Art. No. 146709

Type No. 7090020200

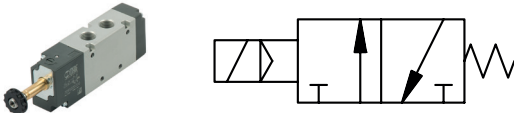

Exemplary illustration

The valves in the »BASIC« series are a numerically-reduced selection of some types of the most commonly used solenoid valves with a particularly good price/performance ratio. Some production processes have been simplified, without affecting product quality and performance. The body is made of anodized aluminium (without painting) and controls are in dark grey technopolymer.

»BASIC« valves can be assembled with accessories of other families of valves, in particular with 22 mm coils, a 8 mm hole and related connectors, modular bases and the multi-position connectors of the series 70 valves.

Technical data

Operating pressure	2.5 - 10 bar
Medium temperature	-10 to 60 °C
Ambient temperature	-10 to 60 °C
Medium	Filtered compressed air with or without lubrication. If lubricated, then continuous.
Sealant	NBR
Flow rate measurement 1	Flow rate at 6 bar and Δp 0.5 bar
Flow rate 1	400 NI/min
Flow rate measurement 2	Flow rate at 6 bar and Δp 1.0 bar
Flow rate 2	550 NI/min
Connection	G 1/8
DN	5
Operation	monostable
Function	3/2 NC
Manual control	latching
Series	Basic
TechnischerHinweis1	Plug and coil are not included in delivery!

Commercial data

Customs tariff number	84818079
Country of origin	IT
eCl@ss 5.1.4	27291501
eCl@ss 9.0	27291390
UNSPSC_Code_v190501	40141603
UNSPSC_CodeDesc_v190501	Pneumatic valves

B1

VALVES SERIES BASIC

VALVES

VALVES SERIES BASIC

The valves in the BASIC series are a numerically-reduced selection of some types of the most commonly used solenoid valves.

They come in sizes 1/8" and 1/4" and in the 3/2 monostable, 5/2 monostable and 5/2 bistable versions.

Some production processes have been simplified, without affecting product quality and performance.

The body is made of anodized aluminium (without painting) and controls are in dark grey technopolymer.

BASIC valves can be assembled with accessories of other families of valves, in particular with 22 mm coils, a 8 mm hole and related connectors, modular bases and the multi-position connectors of the series 70 valves.

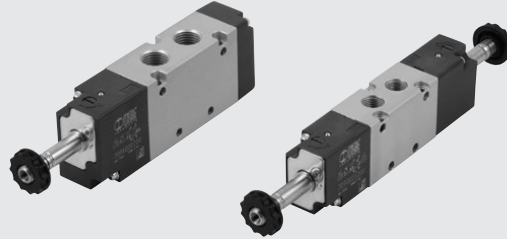

TECHNICAL DATA	1/8"	1/4"
Operating pressure:		
• monostable	bar	2.5 to 10
• bistable	bar	1 to 10
Operating temperature range	°C	-10 to +60
Nominal diameter	mm	5
Conductance C	Nl/min · bar	121.43
Critical ratio b	bar/bar	0.32
Flow rate at 6 bar ΔP 0.5 bar	Nl/min	400
Flow rate at 6 bar ΔP 1 bar	Nl/min	550
TRA / TRR monostable at 6 bar	ms	15/35
TRA / TRR bistable at 6 bar	ms	20/20
Coil voltage values	12; 24 VDC - 24; 110; 220V AC 50/60Hz	
Power	2 W (DC) 3.5VA (AC)	
Voltage tolerance	%	-10 to +15
Insulation class		F 155
Maximum coil nut torque	Nm	1
Hand operator		Bistable
Installation	In any position (vertical assembly is not recommended for bistable valves subjected to vibration)	
Fluid	Filtered air without lubrication; lubrication, if used, must be continuous	
Recommended lubricant	ISO and UNI FD 22	
Maximum coil nut torque	Nm	1
Compatibility with oils	See chapter Z1	

COMPONENTS

- ① VALVE BODY: anodized aluminium
- ② CONTROL/END CAP: plastic
- ③ SPOOL: chemically nickel-plated aluminium
- ④ DISTANCE PLATES: plastic
- ⑤ GASKETS: NBR
- ⑥ PISTONS: Hostaform®
- ⑦ PISTON GASKET: NBR
- ⑧ SPRINGS: special steel
- ⑨ OPERATOR: Brass pipe - Stainless steel core

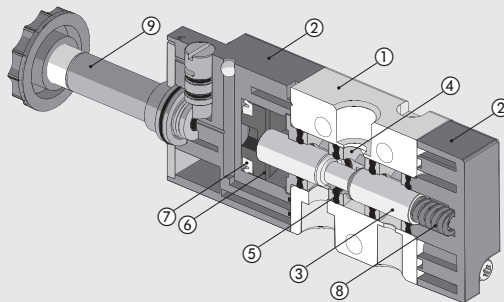

B1.56

FLOW CHARTS

VALVES SERIES BASIC 1/8"

Flow rates

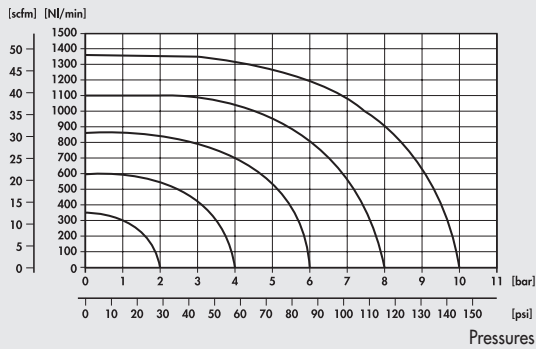

VALVES SERIES BASIC 1/4"

Flow rates

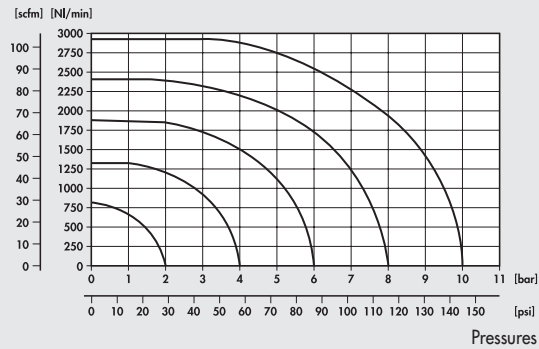

VALVES SERIES BASIC, 1/8"

MONOSTABLE 3/2 NC 1/8"

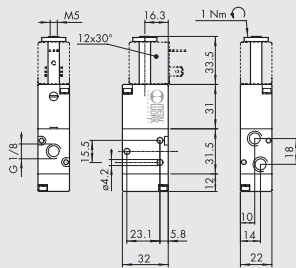

Symbol	Code	Abbrev.	Weight [g]
	7090020200	ELPN 1/8 3/2 MON NC	100

MONOSTABLE 5/2 1/8"

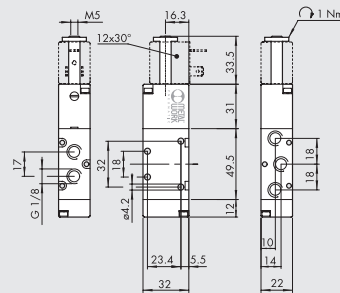

Symbol	Code	Abbrev.	Weight [g]
	7090021100	ELPN 1/8 5/2 MON	128

BISTABLE 5/2 1/8"

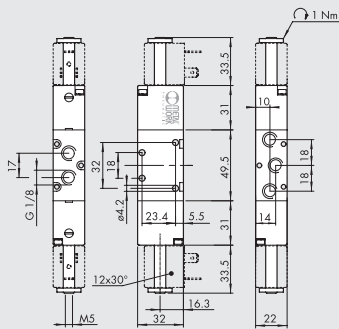

Symbol	Code	Abbrev.	Weight [g]
	7090021200	ELPN 1/8 5/2 BIS	160

NOTES

VALVES

VALVES SERIES BASIC

VALVES SERIES BASIC, 1/4"

VALVES

VALVES SERIES BASIC

MONOSTABLE 3/2 NC 1/4"

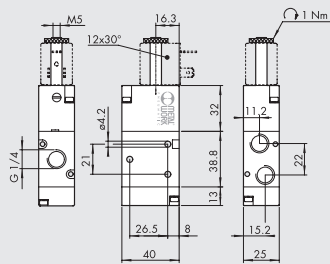

Symbol	Code	Abbrev.	Weight [g]
	7091020200	ELPN 1/4 3/2 MON NC	152

MONOSTABLE 5/2 1/4"

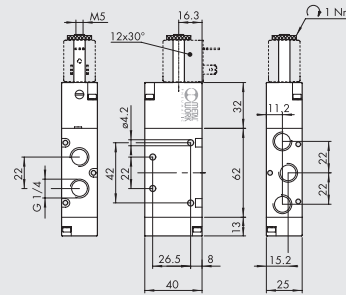

Symbol	Code	Abbrev.	Weight [g]
	7091021100	ELPN 1/4 5/2 MON	200

BISTABLE 5/2 1/4"

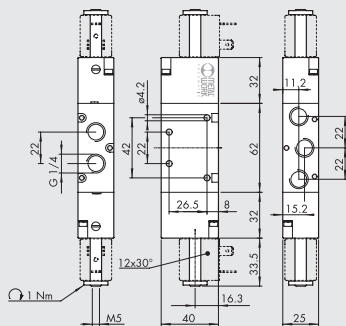

Symbol	Code	Abbrev.	Weight [g]
	7091021200	ELPN 1/4 5/2 BIS	236

NOTES

ACCESSORIES

MULTIPLE BASE 1/8"

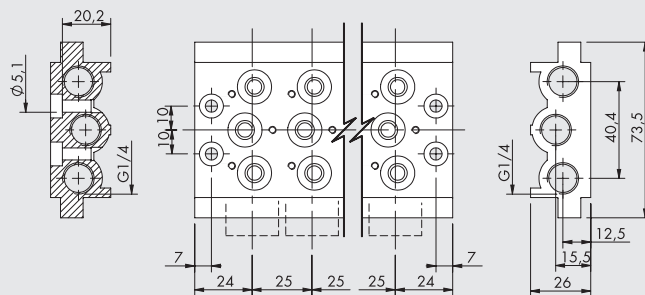

Code	Description	Weight [g]
0223200201	2 positions multiple base BASIC 1/8	236
0223200301	3 positions multiple base BASIC 1/8	321
0223200401	4 positions multiple base BASIC 1/8	407
0223200501	5 positions multiple base BASIC 1/8	494
0223200601	6 positions multiple base BASIC 1/8	587
0223200701	7 positions multiple base BASIC 1/8	711
0223200801	8 positions multiple base BASIC 1/8	760
0223200901	9 positions multiple base BASIC 1/8	842
0223201001	10 positions multiple base BASIC 1/8	923

Note: supplied complete with screws and gaskets

MULTIPLE BASE 1/4"

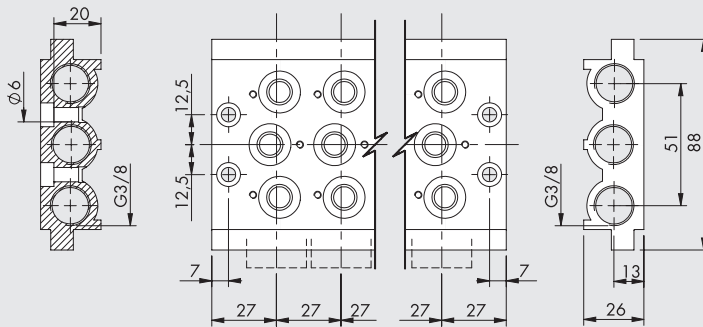

Code	Description	Weight [g]
0224200201	2 positions multiple base BASIC 1/4	296
0224200301	3 positions multiple base BASIC 1/4	406
0224200401	4 positions multiple base BASIC 1/4	515
0224200501	5 positions multiple base BASIC 1/4	624
0224200601	6 positions multiple base BASIC 1/4	733
0224200701	7 positions multiple base BASIC 1/4	845
0224200801	8 positions multiple base BASIC 1/4	956
0224200901	9 positions multiple base BASIC 1/4	1055
0224201001	10 positions multiple base BASIC 1/4	1086

Note: supplied complete with screws and gaskets

GASKET KIT

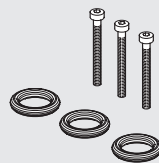

Code	Description	Weight [g]
0226004701	Gasket kit for 1/8 base	5
0226005701	Gasket kit for 1/4 base	5

MANIFOLD BASES



Refer to page B1.44 for manifold bases

MANIFOLDS



Refer to page B1.43 for manifolds

COILS AND CONNECTORS



Refer to page B1.60 for coils and connectors

VALVES

VALVES SERIES BASIC

Accessories

	Art. No.	Type No.
Solenoid 12 V DC, 2 W	118631	400-514-41
Solenoid 24 V DC, 2 W	118632	400-514-42
Solenoid 24 V AC, 50/60 Hz, 3,5 VA	118628	400-514-01
Solenoid 110 V AC, 50/60 Hz, 3,5 VA	118629	400-514-07
Solenoid 230 V AC, 50/60 Hz, 3,5 VA	118630	400-514-17
Plug connector, standard, industrial form B, black	117313	1920.9P
Plug connector with LED, 24 V, transparent	117316	1920.9PL.42
Plug connector with LED, 110 V, transparent	151011	1920.9PL110
Plug connector with LED, 230 V, transparent	117314	1920.9PL.17
Plug connector with LED, varistor 24 V, transparent	117318	1920.9PLV42
Plug connector with LED, varistor 110 V, transparent	129849	1920.9PLV110
Plug connector with LED, varistor 230 V, transparent	117317	1920.9PLV17
Knurled nut, for coil 22 mm, IP 65	145501	0222100100
Multi-base plate for 2 valve positions	146715	0223200201
Multi-base plate for 3 valve positions	146716	0223200301
Multi-base plate for 4 valve positions	146717	0223200401
Multi-base plate for 5 valve positions	146718	0223200501
Multi-base plate for 6 valve positions	146719	0223200601
Multi-base plate for 7 valve positions	146720	0223200701
Multi-base plate for 8 valve positions	146721	0223200801
Multi-base plate for 9 valve positions	146722	0223200901
Multi-base plate for 10 valve positions	146723	0223201001
Modular bases for manifold base system	146733	0226004150
Terminal outlet for manifold base system	146734	0226004201
Terminal inlet for manifold base system	146735	0226004200
Terminal intermediate for manifold base system	146736	0226004300
Feed block with 2 valve positions	106610	518.02-18
Feed block with 3 valve positions	106611	518.03-18
Feed block with 4 valve positions	106612	518.04-18
Feed block with 5 valve positions	106613	518.05-18
Feed block with 6 valve positions	106614	518.06-18
Feed block with 7 valve positions	106615	518.07-18
Mounting bracket set, height 120.0 mm	106604	518.120-18
Mounting bracket set, height 60.0 mm	106605	518.60-18
Mounting bracket set, height 30.0 mm	106606	518.30-18
Solenoid 24 V AC, 50/60 Hz, 5 VA	118633	400-517-01
Solenoid 110 V AC, 50/60 Hz, 5 VA	118634	400-517-07
Solenoid 230 V AC, 50/60 Hz, 5 VA	118635	400-517-17
Solenoid 12 V DC, 5 W	118636	400-517-41
Solenoid 24 V DC, 5 W	118637	400-517-42