

Multi-base plate »BASIC«

for pneumatic and electropneumatic way valves series 70/Basic

Art. No. 146717

Type No. 0223200401



Exemplary illustration

Light alloy multiple bases for 2 to 10 valve positions. Also suitable for valves series 70.

Technical data

Description	Multi-base plate for 4 valve positions
For valve port	G 1/8
Version	with 12 screws and 12 seals
Housing	aluminium

Commercial data

Customs tariff number	84818099
Country of origin	IT
eCl@ss 5.1.4	27299205
eCl@ss 9.0	27299205
UNSPSC_Code_v190501	40141616
UNSPSC_CodeDesc_v190501	Valve parts or accessories

B1

VALVES SERIES BASIC

The valves in the BASIC series are a numerically-reduced selection of some types of the most commonly used solenoid valves. They come in sizes 1/8" and 1/4" and in the 3/2 monostable, 5/2 monostable and 5/2 bistable versions.

Some production processes have been simplified, without affecting product quality and performance.

The body is made of anodized aluminium (without painting) and controls are in dark grey technopolymer.

BASIC valves can be assembled with accessories of other families of valves, in particular with 22 mm coils, a 8 mm hole and related connectors, modular bases and the multi-position connectors of the series 70 valves.

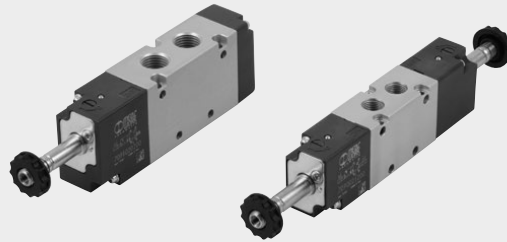

VALVES

VALVES SERIES BASIC

TECHNICAL DATA	1/8"	1/4"
Operating pressure:		
• monostable	bar	2.5 to 10
• bistable	bar	1 to 10
Operating temperature range	°C	-10 to +60
Nominal diameter	mm	5
Conductance C	Nl/min · bar	121.43
Critical ratio b	bar/bar	0.32
Flow rate at 6 bar ΔP 0.5 bar	Nl/min	400
Flow rate at 6 bar ΔP 1 bar	Nl/min	550
TRA / TRR monostable at 6 bar	ms	15/35
TRA / TRR bistable at 6 bar	ms	20/20
Coil voltage values	12; 24 VDC - 24; 110; 220V AC 50/60Hz	
Power	2 W (DC) 3.5VA (AC)	
Voltage tolerance	%	-10 to +15
Insulation class		F 155
Maximum coil nut torque	Nm	1
Hand operator		Bistable
Installation	In any position (vertical assembly is not recommended for bistable valves subjected to vibration)	
Fluid	Filtered air without lubrication; lubrication, if used, must be continuous	
Recommended lubricant	ISO and UNI FD 22	
Maximum coil nut torque	Nm	1
Compatibility with oils	See chapter Z1	

COMPONENTS

- ① VALVE BODY: anodized aluminium
- ② CONTROL/END CAP: plastic
- ③ SPOOL: chemically nickel-plated aluminium
- ④ DISTANCE PLATES: plastic
- ⑤ GASKETS: NBR
- ⑥ PISTONS: Hostaform®
- ⑦ PISTON GASKET: NBR
- ⑧ SPRINGS: special steel
- ⑨ OPERATOR: Brass pipe - Stainless steel core

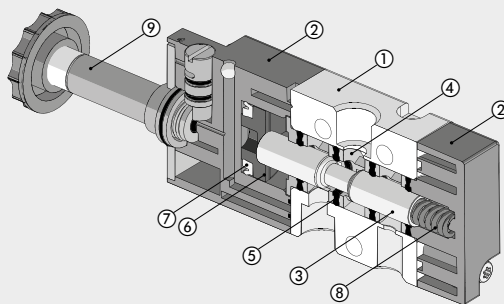

B1.56

FLOW CHARTS

VALVES SERIES BASIC 1/8"

Flow rates

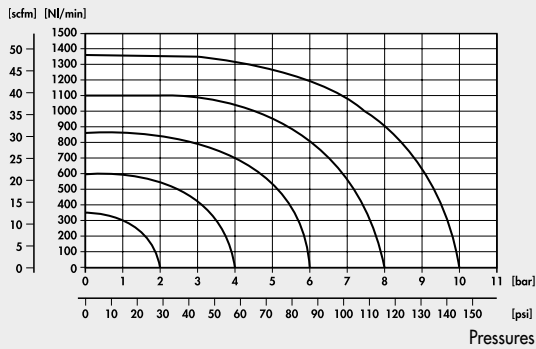

VALVES SERIES BASIC 1/4"

Flow rates

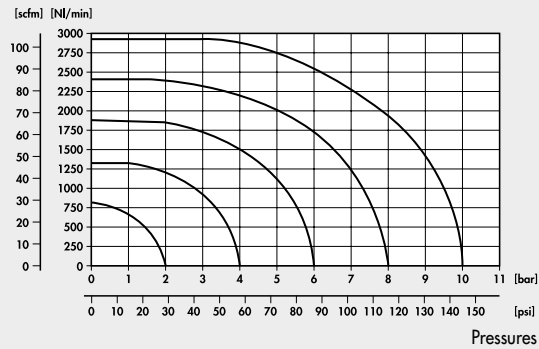

VALVES SERIES BASIC, 1/8"

MONOSTABLE 3/2 NC 1/8"

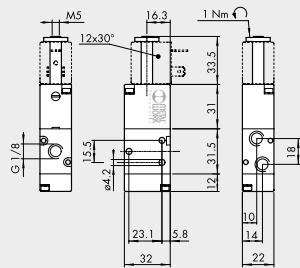

Symbol	Code	Abbrev.	Weight [g]
	7090020200	ELPN 1/8 3/2 MON NC	100

MONOSTABLE 5/2 1/8"

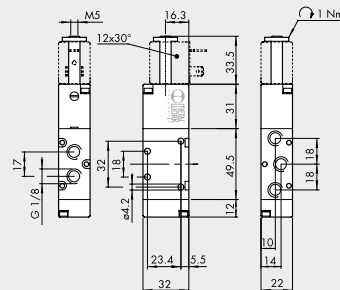

Symbol	Code	Abbrev.	Weight [g]
	7090021100	ELPN 1/8 5/2 MON	128

BISTABLE 5/2 1/8"

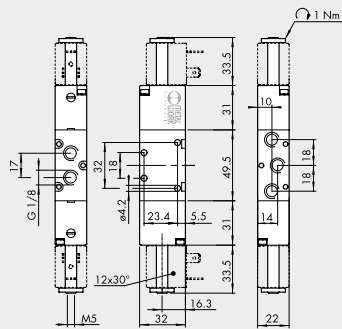

Symbol	Code	Abbrev.	Weight [g]
	7090021200	ELPN 1/8 5/2 BIS	160

NOTES

VALVES

VALVES SERIES BASIC

VALVES SERIES BASIC, 1/4"

VALVES

VALVES SERIES BASIC

MONOSTABLE 3/2 NC 1/4"

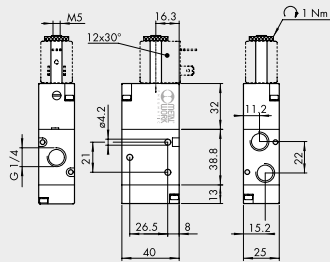

Symbol	Code	Abbrev.	Weight [g]
	7091020200	ELPN 1/4 3/2 MON NC	152

MONOSTABLE 5/2 1/4"

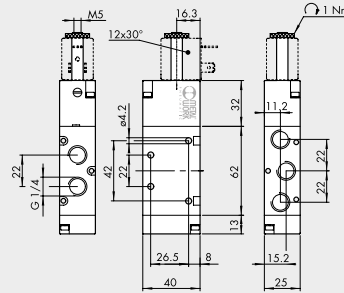

Symbol	Code	Abbrev.	Weight [g]
	7091021100	ELPN 1/4 5/2 MON	200

BISTABLE 5/2 1/4"

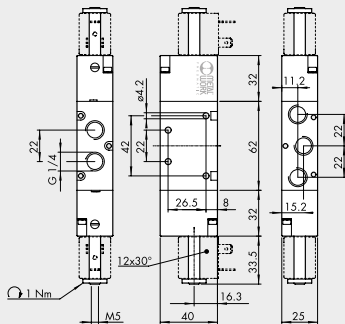

Symbol	Code	Abbrev.	Weight [g]
	7091021200	ELPN 1/4 5/2 BIS	236

NOTES

ACCESSORIES

MULTIPLE BASE 1/8"

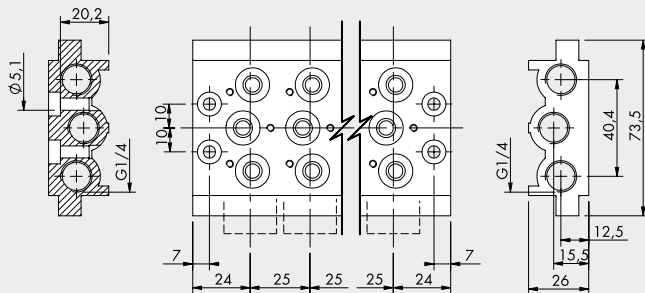

Code	Description	Weight [g]
0223200201	2 positions multiple base BASIC 1/8	236
0223200301	3 positions multiple base BASIC 1/8	321
0223200401	4 positions multiple base BASIC 1/8	407
0223200501	5 positions multiple base BASIC 1/8	494
0223200601	6 positions multiple base BASIC 1/8	587
0223200701	7 positions multiple base BASIC 1/8	711
0223200801	8 positions multiple base BASIC 1/8	760
0223200901	9 positions multiple base BASIC 1/8	842
0223201001	10 positions multiple base BASIC 1/8	923

Note: supplied complete with screws and gaskets

MULTIPLE BASE 1/4"

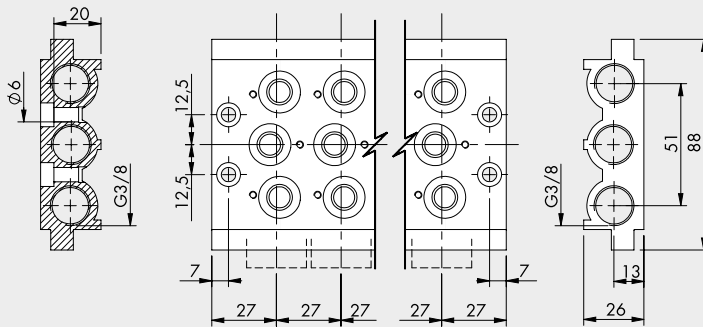

Code	Description	Weight [g]
0224200201	2 positions multiple base BASIC 1/4	296
0224200301	3 positions multiple base BASIC 1/4	406
0224200401	4 positions multiple base BASIC 1/4	515
0224200501	5 positions multiple base BASIC 1/4	624
0224200601	6 positions multiple base BASIC 1/4	733
0224200701	7 positions multiple base BASIC 1/4	845
0224200801	8 positions multiple base BASIC 1/4	956
0224200901	9 positions multiple base BASIC 1/4	1055
0224201001	10 positions multiple base BASIC 1/4	1086

Note: supplied complete with screws and gaskets

GASKET KIT

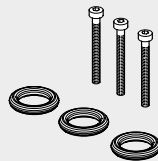

Code	Description	Weight [g]
0226004701	Gasket kit for 1/8 base	5
0226005701	Gasket kit for 1/4 base	5

MANIFOLD BASES



Refer to page B1.44 for manifold bases

MANIFOLDS



Refer to page B1.43 for manifolds

COILS AND CONNECTORS

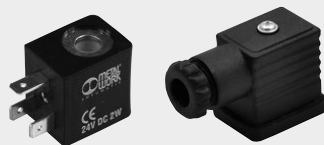

Refer to page B1.60 for coils and connectors

VALVES

VALVES SERIES BASIC

Accessories

	Art. No.	Type No.
Blanking plate, for valves connection G 1/8	106631	520.18-A
Plugs, G 1/8	119139	520.18-V
Omega adapter, G 1/8	146737	0226004600
Intermediate plugs, G 1/8	129152	520.18-Z

Spareparts

	Art. No.	Type No.
Seal set, G 1/8	129904	520.18-DS