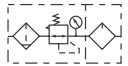

»G-mini« Series

GCL 05, GCL 06

Symbol

Product features

Two-piece service units consisting of a diaphragm pressure regulator, independent of inlet pressure, with self-relieving design, combined with a centrifugal separator and a proportional lubricator.

Specifications / Technical data

Art. No.	Size 200		
	GCL 05	GCL 06	
Fluid	Air		
Port size	1/8"	1/4"	
Filtering grade	5 µm (40 µm on request)		
Pressure range	1.5 to 9 bar (0.15 to 0.9 MPa, 20 to 130 psi)		
Proof pressure	15 bar (1.5 MPa, 215 psi)		
Temperature range	-20 to 70 °C		
Capacity of drain bowl	10 cm ³		
Capacity of oil bowl	25 cm ³		
Recommended lubricant	Mineral oil, viscosity 32 cSt, acc. to DIN 51524 - ISO VG 32		
Weight	430 g		
Constitute	Filter-regulator	GC 05	GC 06
	Lubricator	GL 05	GL 06

Ordering information

Art. No.	Type
GCL 05, GCL 06	Service units, 2-piece with polycarbonate bowl and joiner for wall mounting, semi-automatic drain valve

»G-mini« Series

GCL 05, GCL 06

Pressure chart

GCL 05, GCL 06

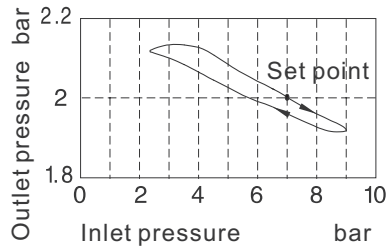

Flow chart

GCL 05, GCL 06

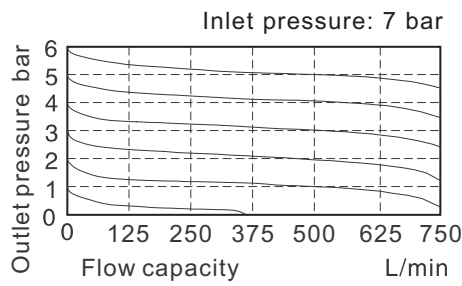

Body dimensions

GCL 05, GCL 06

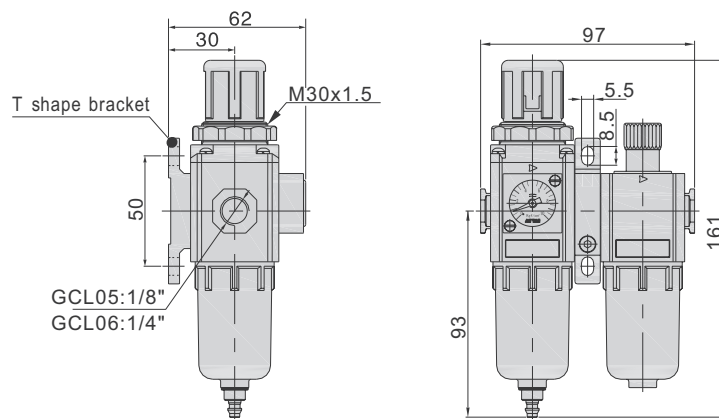

»G-mini« Series

GCL 05, GCL 06





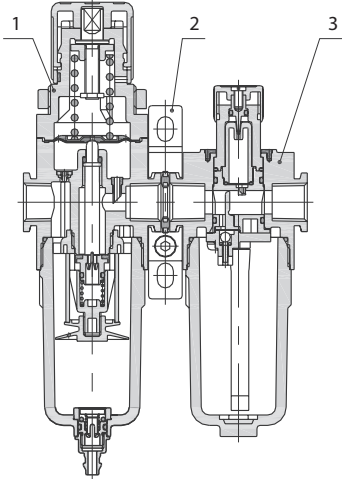





Components and materials

GCL 05, GCL 06



No.	Item	Material (body)
1	G series filter-regulator	Aluminium alloy
2	Bracket	Aluminium alloy
3	G series lubricator	Aluminium alloy

Accessories

	Art. No.	Type
	GR 05 100	Set of wearing parts for pressure regulators/filter regulators = discontinued product. No longer available.
	GR 05 110	Replacement diaphragm = discontinued product. No longer available.
	GR 05 120	Adapter plate for mounting standard pressure gauges (round)
	110.46-KD	Standard pressure gauges
	GF 05 300	Polycarbonate bowl with semi-automatic drain valve for filters/filter regulators
	GL 05 200	Polycarbonate bowl for oil-mist lubricators
	GF 05 400	Filter element 5 µm
	UB 200	Joiner without wall mounting
	LB 200	Joiner with wall mounting, 1 drilled hole
	TB 200	Joiner with wall mounting, 2 drilled holes